

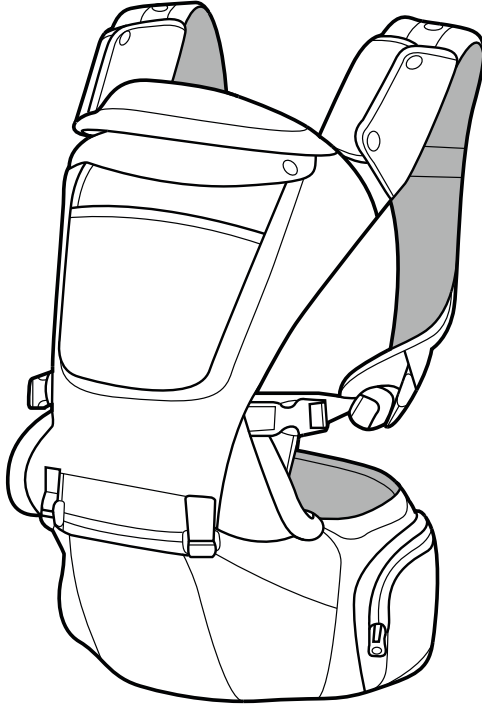

Read all instructions BEFORE
assembly and USE of product.
KEEP INSTRUCTIONS FOR
FUTURE USE.



SideKick™ Plus

3-in-1 Carrier

Owner's Manual



Failure to follow these warnings and the instructions could result in serious injury or death

FALL AND SUFFOCATION HAZARD

•**FALL HAZARD** - Infants can fall through a wide leg opening or out of carrier.

- Adjust leg openings to fit baby's legs snugly.
- Before each use, make sure all buckles, snaps, straps, and adjustments are secure.
- Take special care when leaning or walking.
- Never bend at waist; bend at knees.
- Only use this carrier for children between 7.5 lbs (3.4 kg) to 33 lbs (15 kg).

•**SUFFOCATION HAZARD** - Infants under 4 months can suffocate in this product if face is pressed tight against your body.

- Do not strap infant too tight against your body.
- Allow room for head movement.
- Keep infant's face free from obstructions at all times.

•Child must face towards you until he or she can hold head upright.

- Do not use carrier in the back position with a Child weighing less than 16 lbs (7.3 kg) or more than 33 lbs (15 kg).
- Always secure the Child Leg Straps around the Child before using this Carrier.
- The baby carrier must only be worn by an adult.
- Always properly fit the carrier on you before sitting the baby in it.
- Ensure proper placement of Child in product including leg placement.
- Ensure that you are holding Child safely in your arms.
- Premature infants, infants with respiratory problems, and infants under 4 months are at greatest risk of suffocation.
- It is recommended that you place the infant in the carrier while sitting. Always make sure the baby is securely supported when placing the Child in the carrier.
- Check for ripped seams, torn straps or fabric and damaged fasteners before each use.



Failure to follow these warnings and the instructions could result in serious injury or death

- Never use a soft carrier when balance or mobility is impaired because of exercise, drowsiness, or medical conditions.
- Use the carrier only while standing or walking.
- Never use a soft carrier while engaging in activities such as cooking and cleaning which involve a heat source or exposure to chemicals.
- While using carrier be aware that your balance may be adversely affected by Child's movement.
- This carrier is not suitable for use during sporting activities.
- Do not leave your baby unattended inside the carrier if you are not carrying it on your shoulders.
- Do not use the carrier to hold your baby in a vehicle, in place of a car seat.
- Never wear a soft carrier while driving or being a passenger in a motor vehicle.
- Do not seat more than one infant at a time in the carrier.
- Do not attach any parts to the carrier that are not supplied or expressly approved by Chicco.

•Before use, remove and dispose of plastic bags and other packaging materials, and keep them out of reach of babies and children.

Hip Seat Base Components

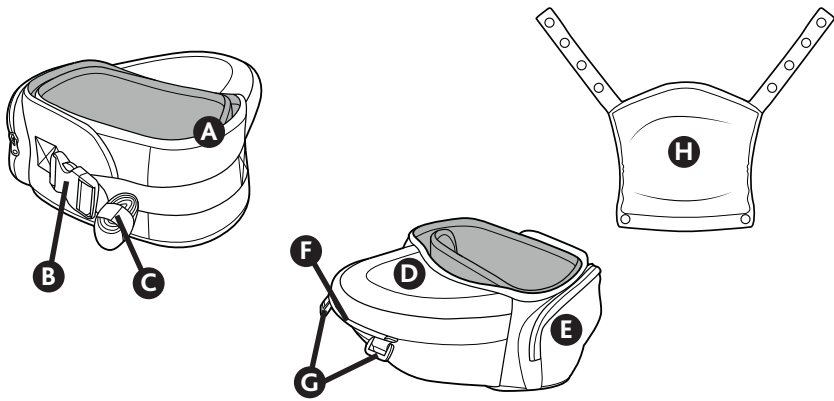

- | | |
|---|--|
| A. Waist Belt | R. Back Buckle |
| B. Waist Belt Buckle | S. Back Buckle Adjustment Strap |
| C. Adjustment Strap | T. Back Buckle Height Adjustment |
| D. Seat Wedge | U. Carrier Backrest |
| E. Storage Pocket | V. Shoulder Strap Buckle |
| F. Carrier Attachment Zipper | W. Child Leg Buckle |
| G. Carrier Attachment Rings | X. Waist Adjustment Strap
(Infant Carrier Mode Only) |
| H. Privacy Hood | Y. Waist Belt Buckles
(Infant Carrier Mode Only) |
| I. Headrest | |
| J. Shoulder Strap | |
| K. Shoulder Strap Covers | |
| L. Shoulder Adjustment Strap | |
| M. Removable Cover | |
| N. Carrier Attachment Straps | |
| O. Waist Belt (Infant Carrier Mode Only) | |
| P. Child Padded Seat | |
| Q. Child Leg Straps | |

Infant Carrier Components

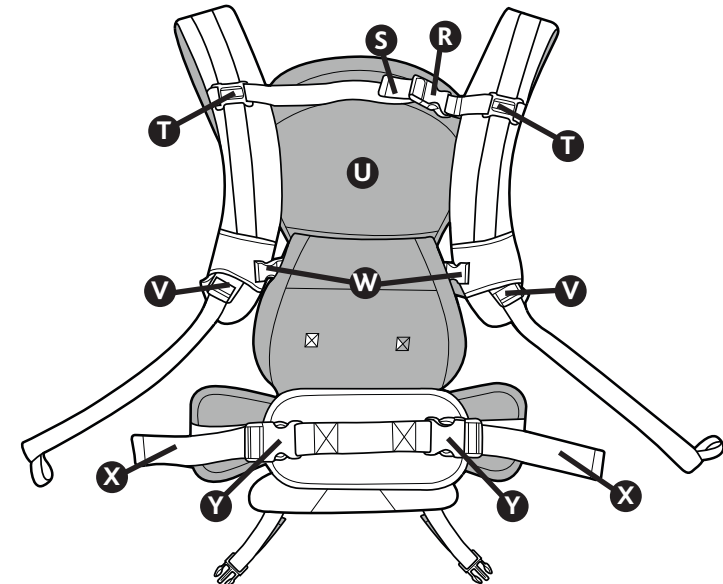
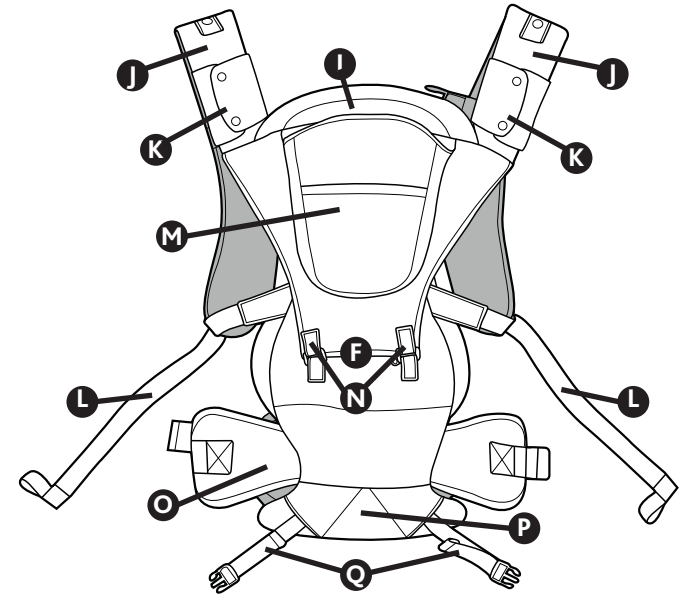

Hip Seat Mode

⚠️ WARNING

Only use Hip Seat for children 4 months old to 33 lbs (15 kg). Keep arm around child at ALL times when using Hip Seat.

1



Parent Facing
4m+

The Hip Seat can be used in the following positions.

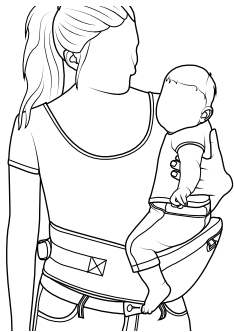

Carrying on Hip
4m+

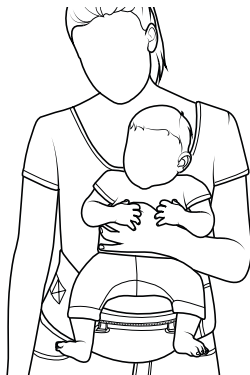

Outward Facing
6m+

Hip Seat Mode

2

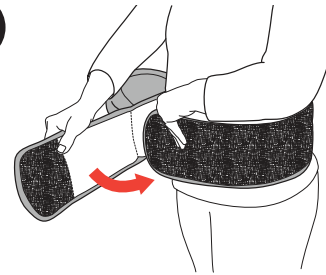

2. Wrap the Waist Belt around your waist and attach the hook and loop sections together. Then buckle the Waist Belt Buckle. Pull on the Adjustment Strap until snug. Roll up the excess length of strap from bottom up and secure it with the elastic band, as shown. Turn the Hip Seat to the front or onto your hip.

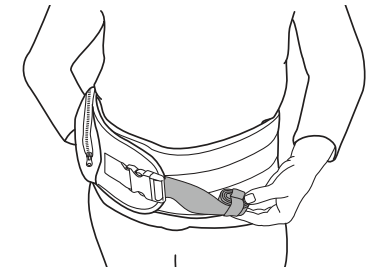
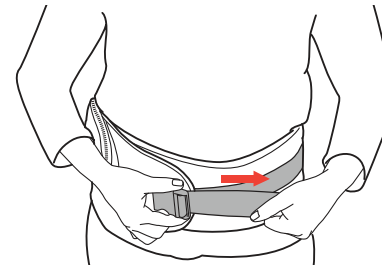
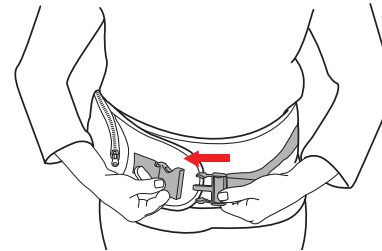

Infant Carrier Mode

⚠️ WARNING

It is recommended that you place the Child in the infant carrier while sitting. Always make sure the baby is securely supported when placing the Child in the carrier.

3

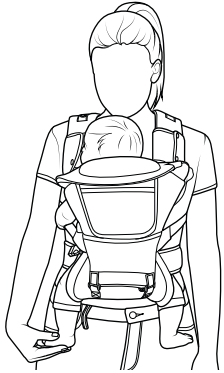

Parent Facing
7.5 lbs (3.4 kg) to 33 lbs (15 kg)

The Infant Carrier can be used for a child from 7.5 lbs (3.4 kg) to 33 lbs (15 kg). Use only in a parent facing position. Before fitting the child in the baby carrier, make sure that you have completed the following steps correctly.

Infant Carrier Mode

4

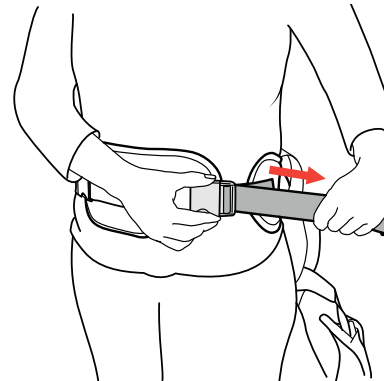
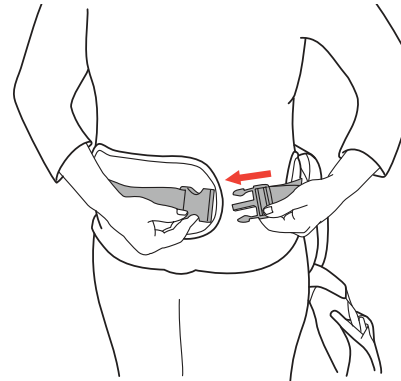

4. Wrap the Infant Carrier Waist Belt around your waist and buckle the Waist Belt Buckle. Adjust the Waist Adjustment Straps for both buckles to tighten the waist belt. Rotate the Infant Carrier Waist Belt around until the infant seat is at the front of your waist.

Infant Carrier Mode

5

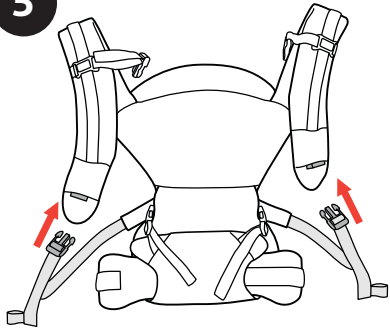

5. Fit the Infant carrier to your shoulders before placing the child in the Infant carrier.

Make sure to attach both Shoulder Strap Buckles and loosen both Adjustment Straps. If necessary, adjust the Back Buckle up or down to better fit your body and unbuckle the Back Buckle. Make sure that both sides are at the same level.

Place both Shoulder Straps onto your shoulders and buckle the Back Buckle. Pull on the adjuster strap for the Back Buckle to tighten.

If the Infant Carrier does not fit properly. Re-adjust the Back Buckle until it fits correctly.

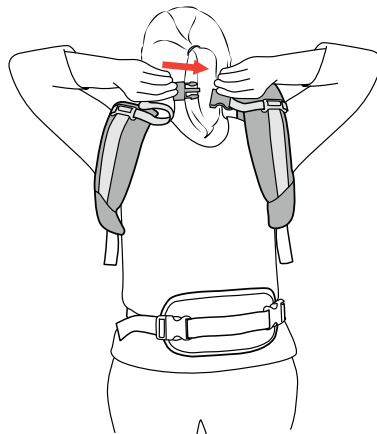
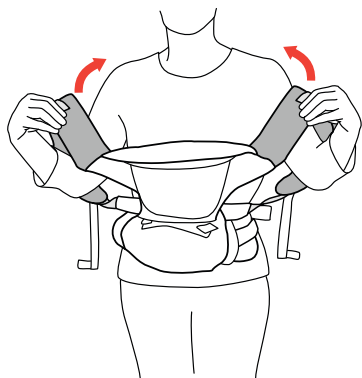
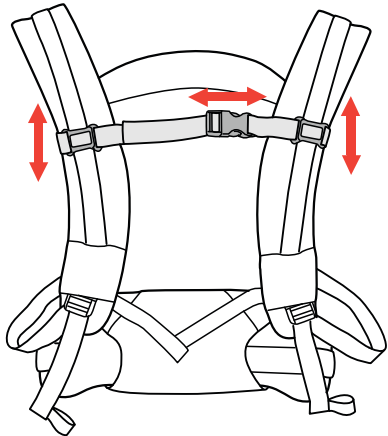

Infant Carrier Mode

⚠ WARNING

FALL HAZARD - Infants can fall through a wide leg opening or out of carrier.

Always secure the Child Leg Straps around the Child before using this Carrier.

Hold your Child safely while carrying out this operation. Ensure that the Child's legs are positioned correctly, straddling the Carrier.

6

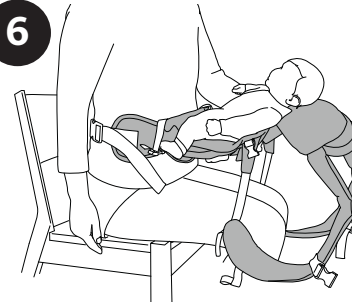

6. To Fit the child to the Infant Carrier, sit on a chair and spread out the Infant Carrier on your lap. Place the child on the Infant Carrier and locate the Child Leg Buckles. Attach both Child Leg Buckles and, adjust the straps so that they are snug around the child's legs. Make sure that the straps are not too tight on the child's legs.

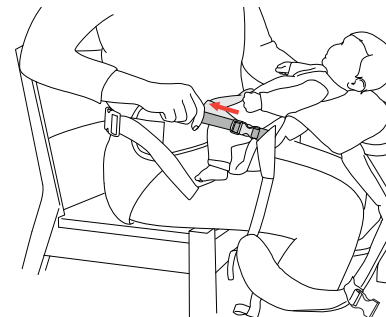
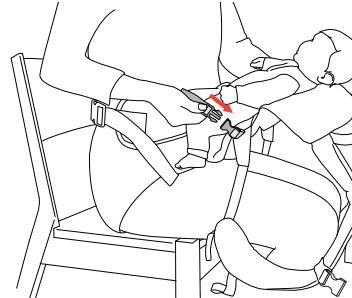

Infant Carrier Mode

⚠ WARNING

Ensure that the area around the baby's face is unobstructed and provides ample air circulation.



7. While securely holding your child, place both shoulder straps over your shoulders.

While supporting the child, adjust the length of each shoulder strap, one at a time, until the child is closely positioned against the upper part of your chest.

Attach the Back Buckle and snug the adjuster strap as shown.

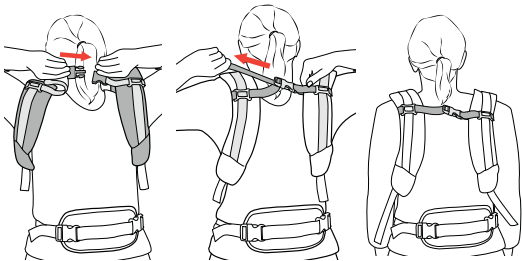
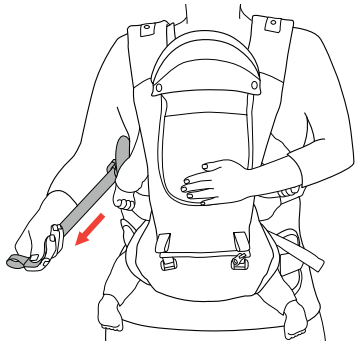

Hip Seat Carrier Mode

Using the Hip Seat Carrier for your child from 7.5 lbs (3.4 kg) to 33 lbs (15 kg).



Front - Parent Facing
7.5 lbs (3.4 kg) to 33 lbs (15 kg)



Front - Outward Facing
6m to 33 lbs (15 kg)



Back - Parent Facing
6m to 33 lbs (15 kg)

Hip Seat Carrier Mode

8

8. To assemble the Hip Seat Carrier, Remove the Carrier Waist Belt. Unbuckle the Carrier Waist Belt and slide it out of the Infant carrier fabric, as shown.

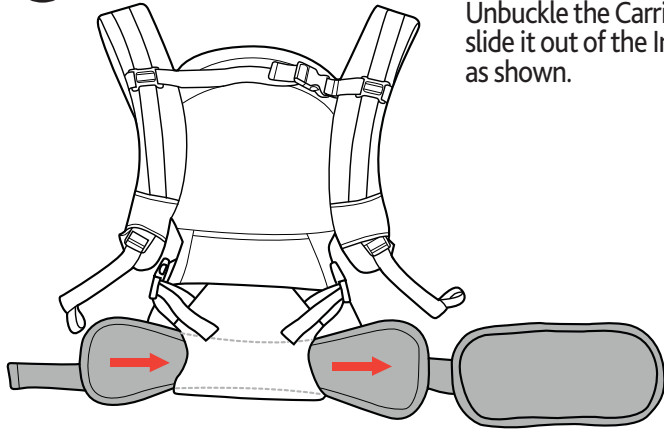

Hip Seat Carrier Mode

9

9. Locate the Carrier Attachment Zipper on the front of the Infant Carrier, and undo both hook and loop straps. Locate the zipper on the Hip Seat, as shown. Line up both sections and zip them together.

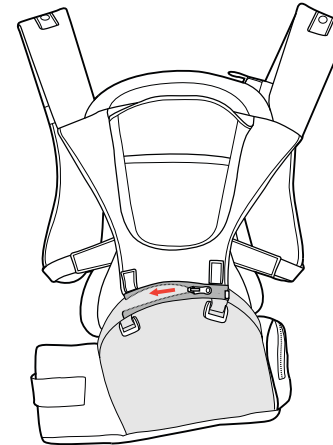
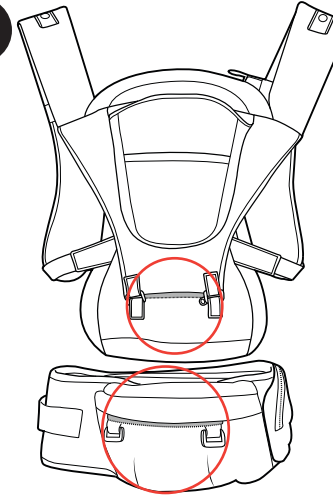

Hip Seat Carrier Mode

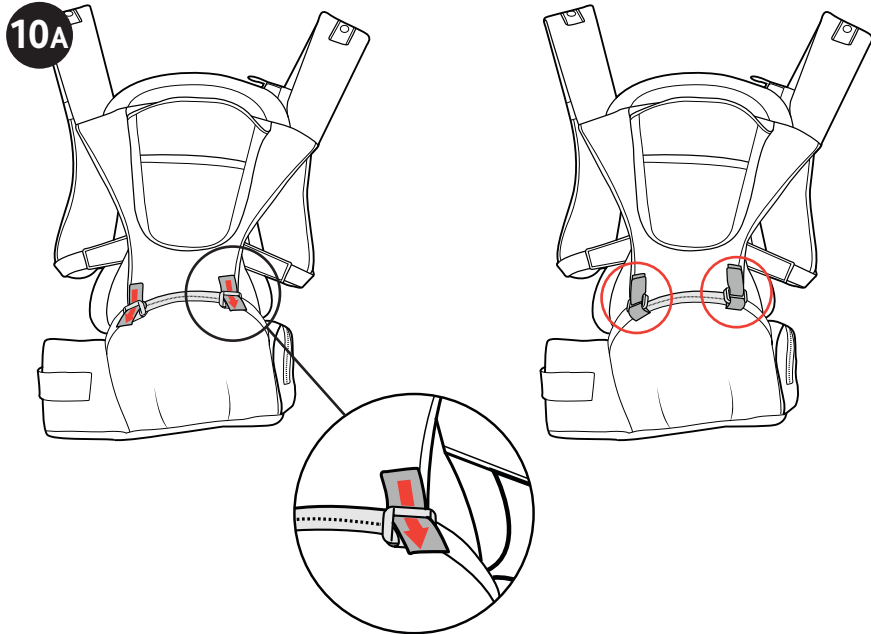

10A. Thread one of the hook and loop straps through the D-ring on the hip carrier and attach, as shown. Repeat for the other side.

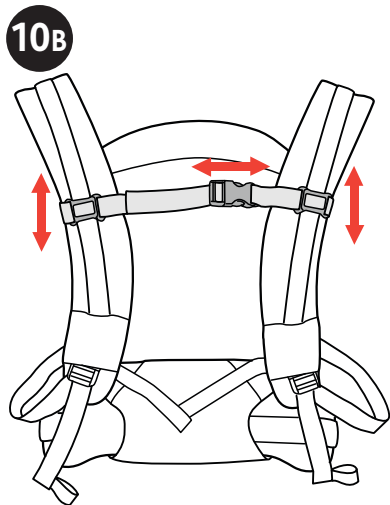

10B. If necessary, adjust the Back Buckle up or down to better fit your body and unbuckle the Back Buckle. Make sure that both sides are at the same level.

Hip Seat Carrier Mode



11. Wrap the Waist Belt around your waist and attach the hook and loop sections together. Then buckle the Waist Belt Buckle. Pull on the Adjustment Strap until snug. Roll up the excess length of strap from bottom up and secure it with the elastic band.

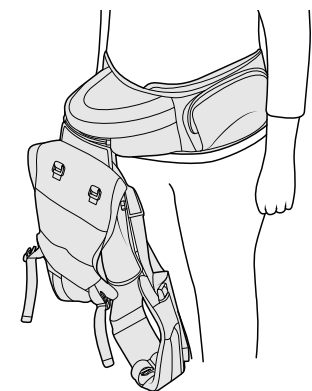
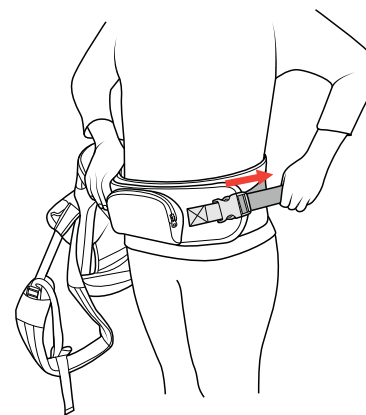
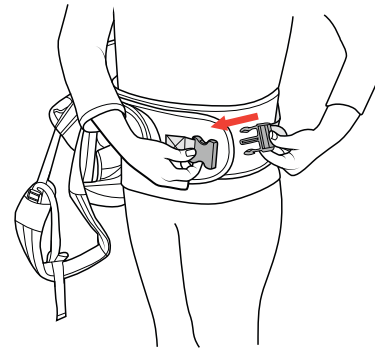

⚠️ WARNING

FALL HAZARD - Infants can fall through a wide leg opening or out of carrier.

Always secure the Child Leg Straps around the Child before using this Carrier.

Hold your Child safely while carrying out this operation. Ensure that the Child's legs are positioned correctly, straddling the Carrier.

12

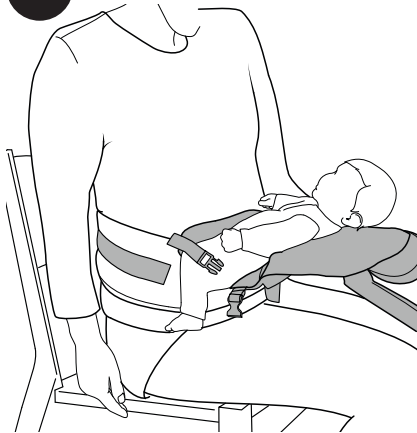

12. While seated on a chair, spread out the Infant Carrier on your lap. Place the child on the Hip Seat Carrier and pull the seat padding up and over the child legs. Attach both Child Leg Buckles and, adjust the straps so that they are snug around the child's legs. Make sure that the straps are not too tight on the child's legs. Follow the same procedure for Outward Facing.

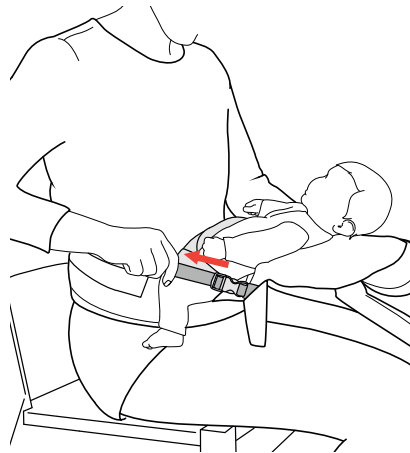
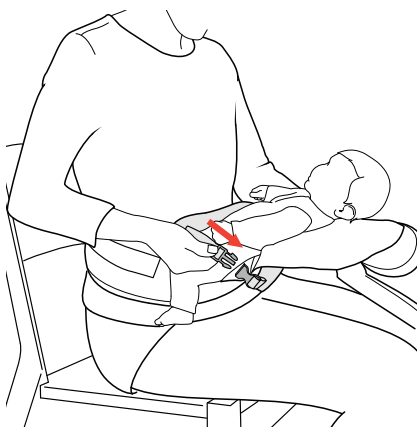

⚠️ WARNING

Ensure that the area around the baby's face is unobstructed and provides ample air circulation.

13



13 While securely holding your child, place both shoulder straps over your shoulders.

While supporting the child, adjust the length of each shoulder strap, one at a time, until the child is closely positioned against the upper part of your chest.

Attach the Back Buckle and snug the adjuster strap as shown.

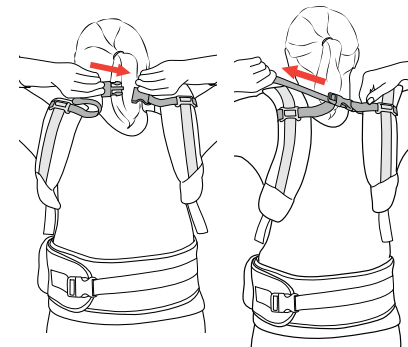
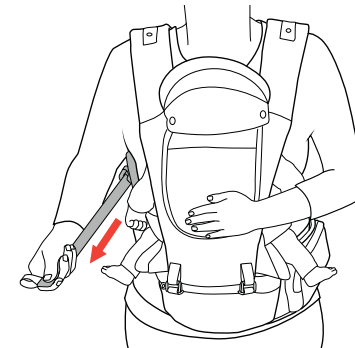

Hip Seat Carrier / Accessories & Features

14

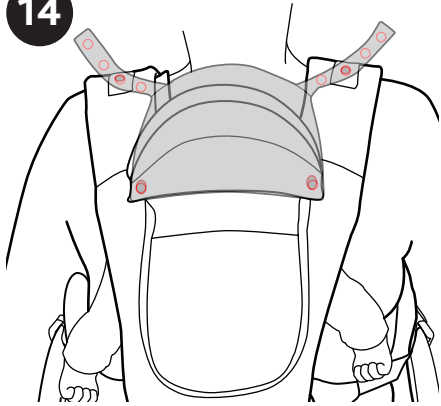

Privacy Hood

14. Attach the Privacy Hood to shield your child from the elements. Attach the lower snap buttons to the fabric flap below the Headrest as shown. Then attach both upper snap button straps to the Shoulder Strap using the set of snap buttons that ensures your child has enough space to breathe properly.

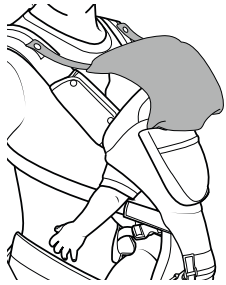

Breathable Mesh Comfort Panel

15. Unzip the zipper on the Front Panel to remove and expose mesh panel.

Front Panel can be stored in Storage Pocket on waist Belt

15

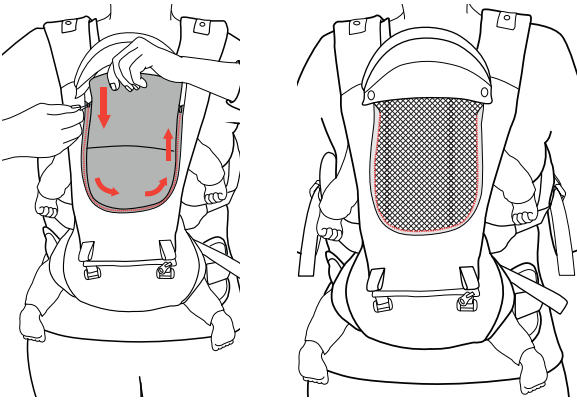

Hip Seat Carrier / Accessories & Features

16

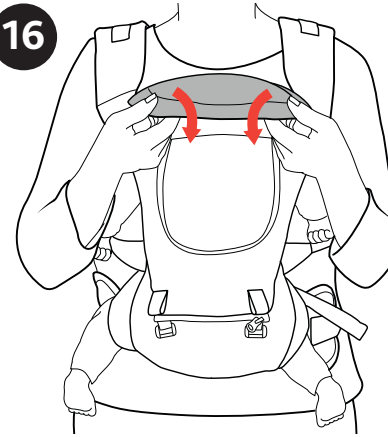

Headrest

16. The headrest can be folded down to make your child more comfortable.

17

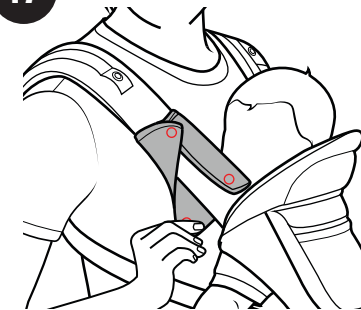

Shoulder Strap Covers

17. To remove the Shoulder Strap Covers for cleaning, undo both snap buttons on the Shoulder Strap Cover and remove. Repeat for the other Shoulder Strap Cover.

Hip Seat Carrier / Back - Parent Facing

⚠️ WARNING

Ensure that the area around the baby's face is unobstructed and provides ample air circulation.

18

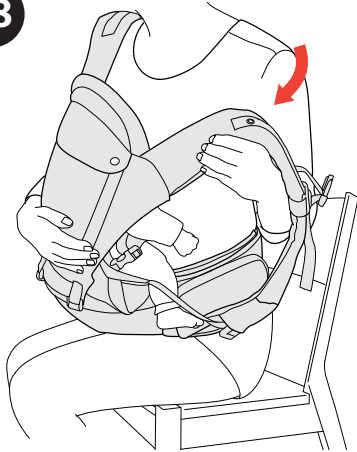

18. While sitting down, undo the Back Buckle and slide one shoulder strap off of your shoulder. Using that same arm, slide the arm between your chest and the infant carrier. Grab the opposite shoulder strap, as shown.

While holding onto the child securely, rotate the carrier onto your back. Then slide both arms into the shoulder straps.

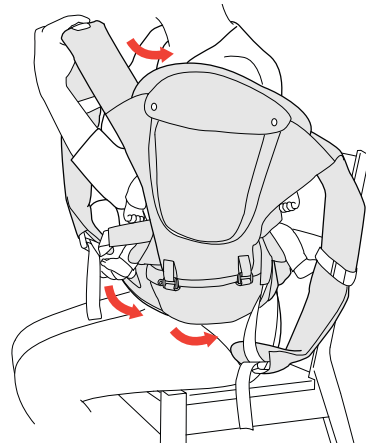
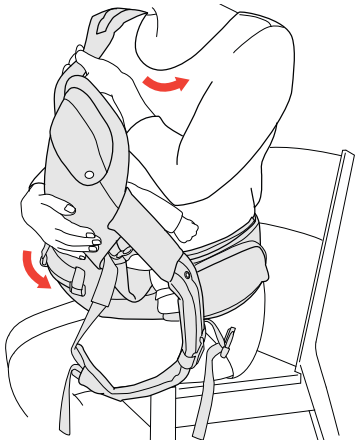

Hip Seat Carrier / Back - Parent Facing

19



19. Attach the Back Buckle on the chest, as shown. Pull on the Shoulder Strap adjuster straps to tighten the shoulder straps.

Cleaning and Maintenance

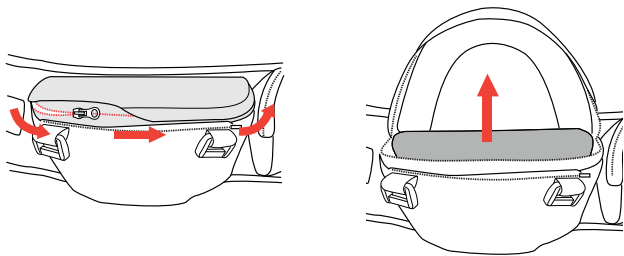

INFANT CARRIER CARE:

Before washing the Hip Seat base, remove the wedge from the compartment by unzipping the zipper. Spot clean with damp cloth and mild, soapy water. Or hand wash only in warm soapy water. Air dry. After each washing check that the fabric and seams are not worn or damaged.

HOOD AND SHOULDER STRAP COVERS:

Spot clean with damp cloth and mild, soapy water. Or hand wash only in warm soapy water. Air dry. Do not use bleach.

CARRIER MAINTENANCE:

Check the seams and baby carrier regularly to ensure that they are not worn or damaged, and that no part is missing. If any part is worn or missing, do not use this product.

For More Information

For USA customers :

If you have any questions or comments about this product, or are missing any of the parts, please do not return this product to the store. Contact us in one of the following ways:



(877)-424-4226



info.usa@artsana.com



www.chiccousa.com



1826 William Penn Way
Lancaster, PA 17601



www.chiccousa.com