

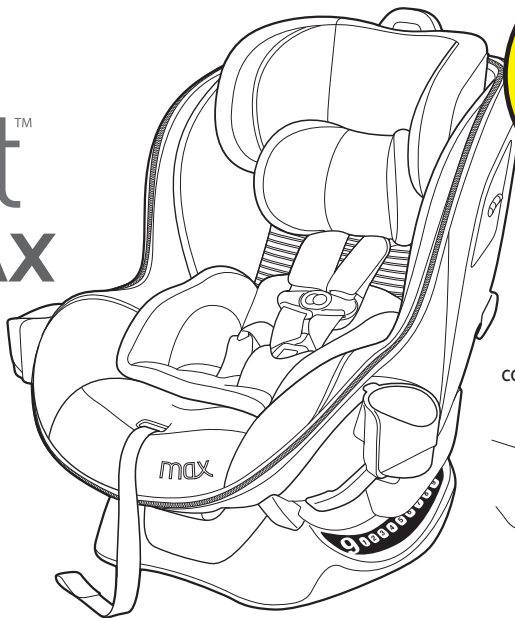

# Nextfit™ ZIPO MAX

Convertible  
Car Seat  
User Guide



For future use,  
STORE USER GUIDE in  
compartment at rear of base.

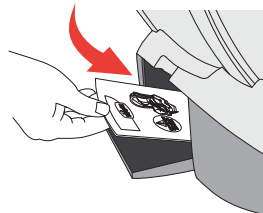

If you have any problems with your Chicco Child Restraint, or any questions regarding installation or use, please call:

**Chicco Customer Service**  
**1-877-424-4226**

Please have Model and Serial Number available when you call. These are located on a label on the bottom of the Child Restraint.

For future reference, fill in the information below. The information can be found on the label on the bottom of the Child Restraint.

Model Number: \_\_\_\_\_

Serial Number: \_\_\_\_\_

Manufactured In: \_\_\_\_\_

## TABLE OF CONTENTS

Registration and Recall	2	<b>REAR-FACING INSTALLATION</b>	
Child Guidelines	4	Rear-Facing Setup	40
Safe Use Checklist	6	Install Using <b>LATCH</b>	44
Important Warnings	8	Install Using <b>LAP-SHOULDER BELT</b>	50
Best Practices	14	Install Using <b>LAP BELT ONLY</b>	54
Need Help?	15		
<b>CHILD RESTRAINT OVERVIEW</b>			
Child Restraint Components	16	Forward-Facing Setup	58
LATCH and Tether Components	18	Install Using <b>LATCH</b>	62
LATCH and Tether Storage	20	Install Using <b>LAP-SHOULDER BELT</b>	68
Selecting Rear/Forward-Facing Position	22	Install Using <b>LAP BELT ONLY</b>	74
Adjusting Crotch Strap	26		
Newborn Positioner	28	<b>SECURING YOUR CHILD</b>	
Newborn Headrest	30	Securing Child with Harness	78
		Secure Child Checklist	90
<b>VEHICLE INFORMATION</b>			
Vehicle Seating Positions	32	<b>ADDITIONAL INFORMATION</b>	
Vehicle Seat Belts	34	Installation on an Aircraft	92
What is LATCH?	36	Cup Holder	94
What is a Tether?	38	Cleaning and Maintenance	96

Please complete the Registration Card that came with your Child Restraint and mail it promptly.

Child Restraints could be recalled for safety reasons. You must register this restraint to be reached in a recall. Send your name, address, e-mail address if available, and the restraint's model number and manufacturing date to:

**Artsana USA, Inc.**  
**1826 William Penn Way**  
**Lancaster, PA 17601**  
or call 1-877-424-4226

or register online at <http://www.chiccousa.com/carseatregistration.aspx>

For recall information, call the U.S. Government's Vehicle Safety Hotline at 1-888-327-4236 (TTY: 1-800-424-9153), or go to <http://www.NHTSA.gov>.

PAGE INTENTIONALLY LEFT BLANK

## CHILD GUIDELINES

This Child Restraint is designed for children ages Birth to 6 years old. **ONLY** use this Child Restraint if the child meets **BOTH** of the following Weight and Height requirements:

- **Weight is between 4 and 65 pounds (1.8 and 29.5 kg).**
- **Height is 49 inches (125 cm) or less.**

The Newborn Positioner and Newborn Headrest are only for infants who weigh between 4 and 11 pounds (1.8 and 5 kg). See Newborn Positioner on page 28 and Newborn Headrest on page 30.

⚠ For premature infants, you must consult the infant's doctor before using this Child Restraint. A premature infant may have difficulty breathing or have other medical problems when placed in a seated position.

## CHILD GUIDELINES

See Select Rear-Facing on page 22.

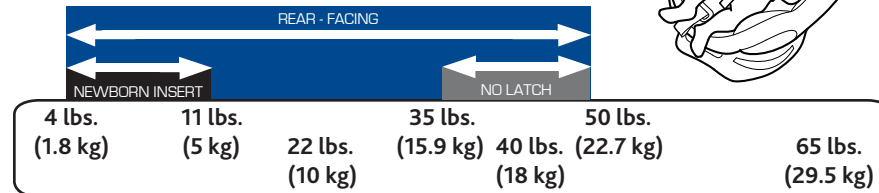

See Select Forward-Facing on page 24.

## SAFE USE CHECKLIST

**⚠ YOUR CHILD'S SAFETY DEPENDS ON YOU!** You MUST follow the detailed instructions in this User Guide to ensure the steps below are performed correctly!

- Make sure your child meets the age, weight, and height requirements:**  
Refer to the "Child Guidelines" section on page 4.

- Choose the proper Child Restraint configuration:**

**REAR-FACING** requirements on page 22

**FORWARD-FACING** requirements on page 24

- Select a safe seating location in your car:**  
Refer to the "Vehicle Seating Positions" section on page 32 and 33.



## SAFE USE CHECKLIST

- Ensure that the Child Restraint is properly leveled when installed:**

**REAR-FACING** requirements on page 40

**FORWARD-FACING** requirements on page 58

- Check Child Restraint for a snug fit in your car:**  
While holding Child Restraint near belt path used, pull side to side and forward. Belt should remain tight and Child Restraint should not move more than 1" (25 mm) from vehicle seat back or side-to-side.
- Secure your child:**  
Refer to the "Securing Your Child" section on page 78.



**FAILURE TO FOLLOW THESE INSTRUCTIONS AND THE PRODUCT LABELS CAN RESULT IN SERIOUS INJURY OR DEATH TO YOUR CHILD.**

### **Take Time to Read This User Guide**

- Carefully read and understand all instructions and warnings in this User Guide. Your child's safety depends on you knowing how to setup, install and use this Child Restraint properly.
- Before installing this Child Restraint in a vehicle, be sure to also check the vehicle owner's manual for information on proper installation.
- **NEVER** allow others to use this Child Restraint until they have read and understood all instructions in this User Guide.
- This Child Restraint is not intended for use outside of the vehicle.

### **Make Sure Child Fits This Child Restraint**

- Use only with children who weigh between 4 lbs (1.8 kg) and 65 lbs (29.5 kg) and whose height is 49 inches (125 cm) or less. Determine the right installation setup for your child's age, weight and height.
- **ONLY USE** the Newborn Positioner REAR-FACING and only if the child weighs between 4 and 11 lbs (1.8 and 5 kg).



### **Secure Child Properly**

- Snugly adjust the harness around your child. A loose harness could cause the child to be ejected in a sudden stop or crash, resulting in serious injury or death.

A snug strap should not allow any slack. It lies in a relatively straight line without sagging. It does not press on the child's flesh or push the child's body into an unnatural position.

- **NEVER** use clothing or blankets that interfere with fastening or tightening the harness. An unsecured child could be ejected in a sudden stop or crash!

To keep child warm, place a blanket over child and restraint AFTER you have properly secured child in harness.

- **ALWAYS** check to make sure buckle is securely latched. If buckle separates, child could be killed or seriously injured.
- **NEVER** leave child unattended. Do not allow children to play in or around the Child Restraint.
- **ALWAYS** keep child properly secured in harness whenever child is in Child Restraint.



### Install Child Restraint Correctly

- **WHEN USING THIS CHILD RESTRAINT REAR-FACING, DO NOT PLACE THIS CHILD RESTRAINT IN VEHICLE SEATING LOCATION WITH A FRONTAL AIR BAG, UNLESS THE AIR BAG CAN BE TURNED OFF.** If the airbag inflates, it can cause serious injury or death to your child. For vehicles with side air bags, refer to your vehicle owner's manual for information on your Child Restraint installation.
- **ALWAYS** install this Child Restraint in a back seat if possible.

According to accident statistics, children are safer when properly restrained in the rear seating positions rather than in the front seat.

- **NEVER** install on a rear-facing or side-facing vehicle seat, or on the back of a folded down vehicle seat.
- **ALWAYS** secure this Child Restraint with the vehicle's Child Restraint anchorage system (LATCH) if available OR the vehicle seat belt. Refer to Page 5 for proper use/child weight limits when installing with LATCH.
- **DO NOT** use the lower anchors of the Child Restraint anchorage system (LATCH system) to attach this Child Restraint **REAR-FACING** when restraining a child weighing more than **35 lbs (15.9 kg)** or **FORWARD-FACING** when restraining a child weighing more than **40 lbs (18 kg)**.



### Install Child Restraint Correctly

- **ALWAYS** use the top tether strap on this Child Restraint when installed FORWARD-FACING, if a tether anchor is available. **NEVER** use the top tether strap on this child restraint when installed REAR-FACING.
- **NEVER** use Child Restraint in a vehicle seating position where it cannot be secured tightly. A loosely installed Child Restraint will not protect your child in a crash.
- **Never leave Child Restraint unsecured in your vehicle even when it is unoccupied.** It could injure other occupants in a sudden stop or crash.
- **DO NOT** install this Child Restraint using an inflatable seat belt. The interaction of the inflatable portion of the vehicle's belt with this Child Restraint **can result in serious injury or death.** Install using LATCH instead, or move the car seat to a position with a suitable seat belt type.

### Ensure Child's Safety When Using Child Restraint

- **NEVER leave your child unattended in the vehicle.**
- **STRANGULATION HAZARD:** Your child can strangle in a loose Restraint Harness. Never leave a child in the Child Restraint with straps loose or undone.
- To **prevent ejection or breathing difficulties, proper recline is required.** When installing the Child Restraint, check the bubble level on the side of the Child Restraint.



### Check Condition of Restraint

- **DO NOT** use if the Harness or LATCH straps are cut, frayed or damaged.
- **DO NOT use this Child Restraint if it is more than 8 years old.** Check manufacturer's label on underside of Child Restraint for the "Do Not Use After" date.
- **DO NOT use any accessories, pads or products not included with this Child Restraint, unless approved by Chicco USA.** Doing so will void the warranty of this Child Restraint.
- You **MUST** replace this Child Restraint if it has been involved in a crash, even if you cannot see visible damage. A damaged Child Restraint may not protect your child in a future crash.
- **Do not modify your Child Restraint.**
- **NEVER** remove harness from Child Restraint without the proper removal and installation instructions available from Chicco USA. Contact us by visiting the Chicco website at [www.chiccousa.com](http://www.chiccousa.com) or call 1-877-424-4226.
- **Do not use Child Restraint if any component is damaged, broken, or missing parts.** Call 1-877-424-4226 to find out if the damaged part or parts can be replaced.

PAGE INTENTIONALLY LEFT BLANK



- Ensure all vehicle occupants are properly restrained before traveling. Unrestrained occupants can be thrown around and may be seriously injured or seriously injure other occupants in a sharp turn, sudden stop or crash.
- Do not leave loose objects, such as books, bags, etc., in the back of the vehicle. In the event of a sharp turn, sudden stop, or crash, loose objects can be thrown around and possibly cause serious injury to vehicle occupants.
- Cover the Child Restraint when the vehicle is parked in sunlight. Parts of a Child Restraint can become very hot if left in the sun. Contact with these parts can burn a child's skin. Always check the surface of any metal or plastic parts before putting your child in the Child Restraint.
- To avoid strangulation, Do not allow children to play with vehicle seat belts. If possible, move unused belts out of reach.
- Do not use anything to raise the Child Restraint off the vehicle seat such as a noodle or towel. In a sharp turn, sudden stop, or crash, the Child Restraint could slide and potentially cause serious injury.
- Never use a second-hand Child Restraint with an unknown history.
- Never use any accessories that are not included with this Child Restraint, unless specifically approved by Chicco. For more information, go to [www.chiccousa.com](http://www.chiccousa.com).

### **Need Help Securing Your Child Restraint?**

The following sources are available to help ensure your Child Restraint is properly installed:

- Contact Chicco, USA by visiting our website at [www.chiccousa.com](http://www.chiccousa.com) or calling our Customer Service 1-877-424-4226. Please have Model and Serial Number available when you call. These are located on a label on the bottom of the Child Restraint.
- Refer to your vehicle manual for Child Restraint installation tips.
- Contact a certified Child Passenger Safety Technician in your area by visiting [safercar.gov](http://safercar.gov) and select "Find Local Child Seat Help" or call 1-866-SEAT CHECK (1-866-732-8243).

## CHILD RESTRAINT COMPONENTS

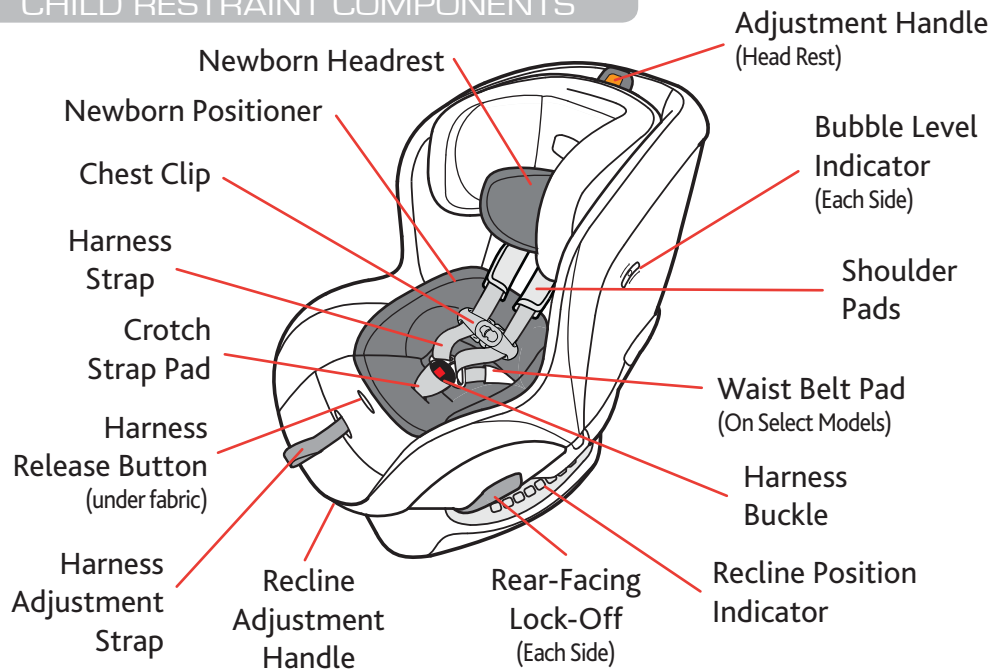

## CHILD RESTRAINT COMPONENTS

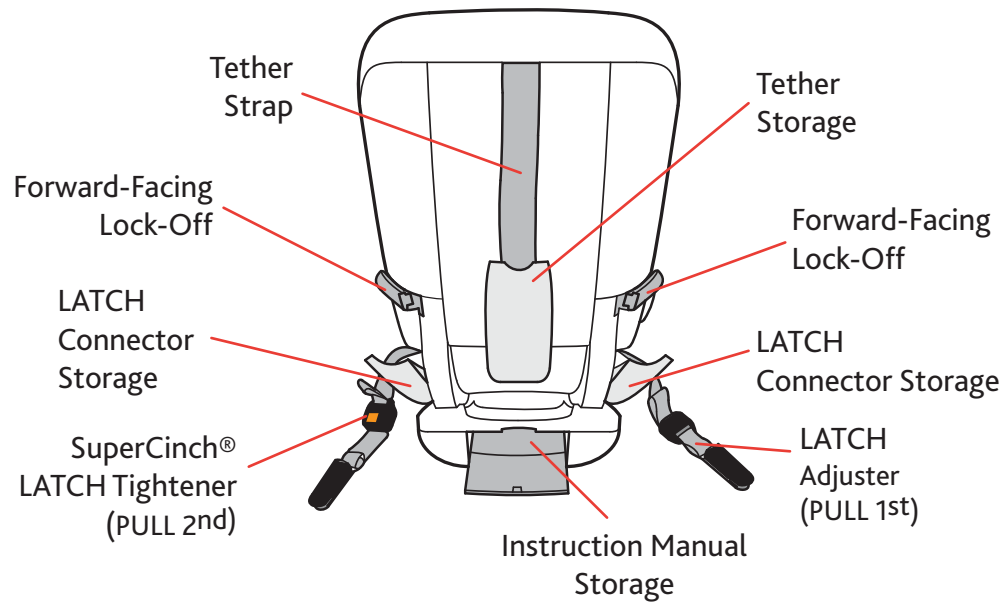

## LATCH AND TETHER COMPONENTS

**TETHER:**

- A** Tether Strap
- B** Tether Strap Adjuster
- C** Tether Hook

**LATCH:**

- D** LATCH Adjuster (PULL 1<sup>st</sup>)
- E** SuperCinch® LATCH Tightener (PULL 2<sup>nd</sup>)
- F** LATCH Strap
- G** LATCH Connectors

## LATCH AND TETHER COMPONENTS

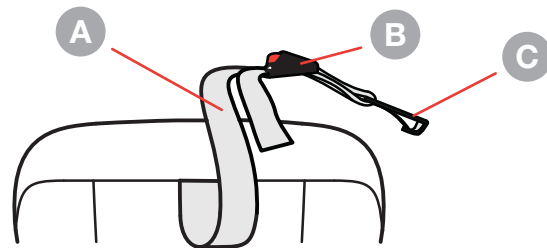
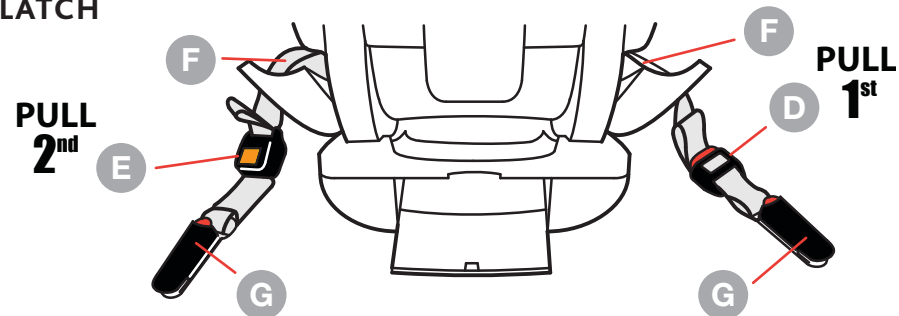
**Tether****LATCH**

## LATCH AND TETHER STORAGE

⚠ Always make sure LATCH Components are properly stored in the compartments when not in use.

**LATCH STORAGE:**

- 1 Store each LATCH strap in the compartments located on either side of the Child Restraint base when not in use. Make sure Lower Anchor Connector Storage compartments are properly closed.

Fold SuperCinch® LATCH Tightener (Pull 2<sup>nd</sup>) strap as shown (1a).

**TETHER STORAGE:**

Store Tether in the compartment in the back of Child Restraint when not in use. Hook on bar and pull strap tight. Make sure compartment door is properly closed.

## LATCH AND TETHER STORAGE

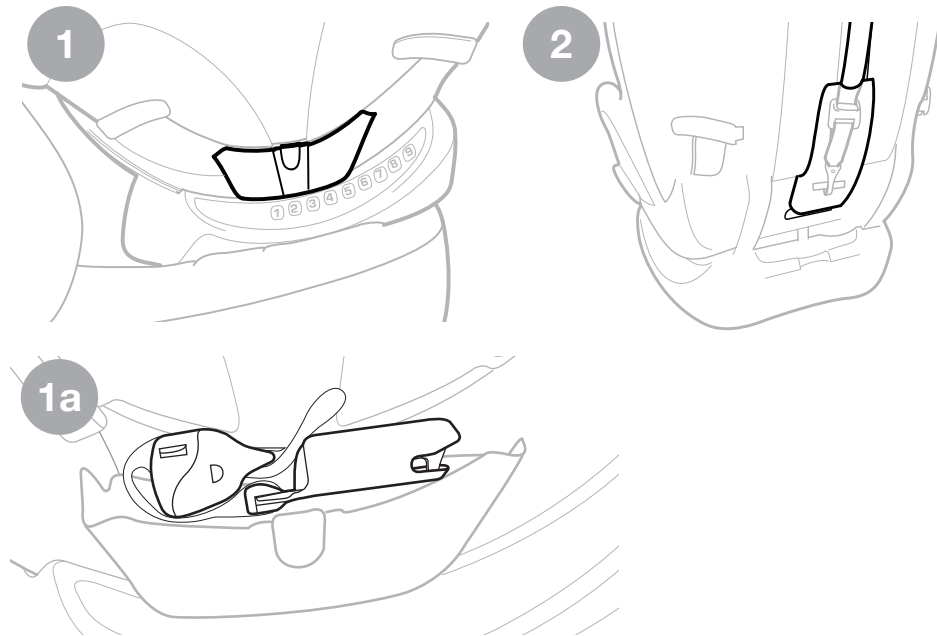

## SELECT REAR-FACING POSITION

**⚠ WARNING! REAR-FACING** use of this Child Restraint is **ONLY** for children who meet ALL of the requirements shown here. If the child is not within these requirements because the child is too large, review the FORWARD-FACING guidelines on page 24.

**⚠ NEVER** turn this Child Restraint FORWARD-FACING with an infant less than one year of age.

## SELECT REAR-FACING POSITION

**REAR-FACING:**  
4 – 50 lbs (1.8 – 22.7 kg)

Use **REAR-FACING** with children:

- Who weigh between 4 and 50 lbs (1.8 – 22.7 kg).
- Who are no taller than 43" (109 cm).
- When Harness Straps can be positioned at or below the child's shoulders\*.

See Harness Height Adjustment on page 82.

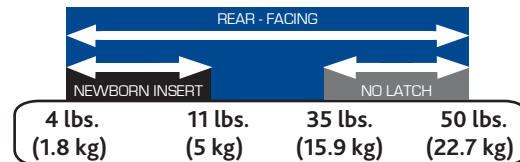

## SELECT FORWARD-FACING POSITION

**⚠ WARNING! FORWARD-FACING** use of this Child Restraint is **ONLY** for children who meet ALL of the requirements shown here. If the child is not within these requirements because they are too large, select a different child seat. If the child is not within these requirements because the child is too small, review the REAR-FACING guidelines on page 22.

**⚠ NEVER** turn this Child Restraint FORWARD-FACING with an infant less than one year of age.

## SELECT FORWARD-FACING POSITION

**FORWARD-FACING:**  
22 – 65 lbs (10 – 29.5 kg)

Use **FORWARD-FACING** with children:

- Who are at least one year old.
- Who weigh between 22 and 65 lbs (10 –29.5 kg).
- Who are no taller than 49" (125 cm) **OR** when the top of the ears are below the top of the Head Rest.
- When Harness Straps can be positioned at or above the child's shoulders\*.

See Harness Height Adjustment on page 82.

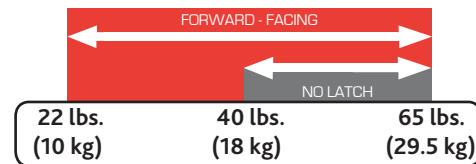

## ADJUSTING CROTCH STRAP

*Adjust Crotch Strap if strap is underneath child.*

- 1 Unbuckle Harness Straps. Remove Crotch Strap Pad (Refer to page 96). Unzip the seat padding halfway (a). Pull seat pad to the side to access the Crotch Strap compartment (b).
- 2 Slide the orange button on the Crotch Strap lock while pulling up on the Crotch Strap to open the compartment (a, b). Then pull the Crotch Strap forward or backward into desired position.
- 3 Close the compartment by pushing down on the door until it locks back into place. Check to make sure compartment is locked by pulling up on the Crotch Strap. Re-attach the seat pad.

## ADJUSTING CROTCH STRAP

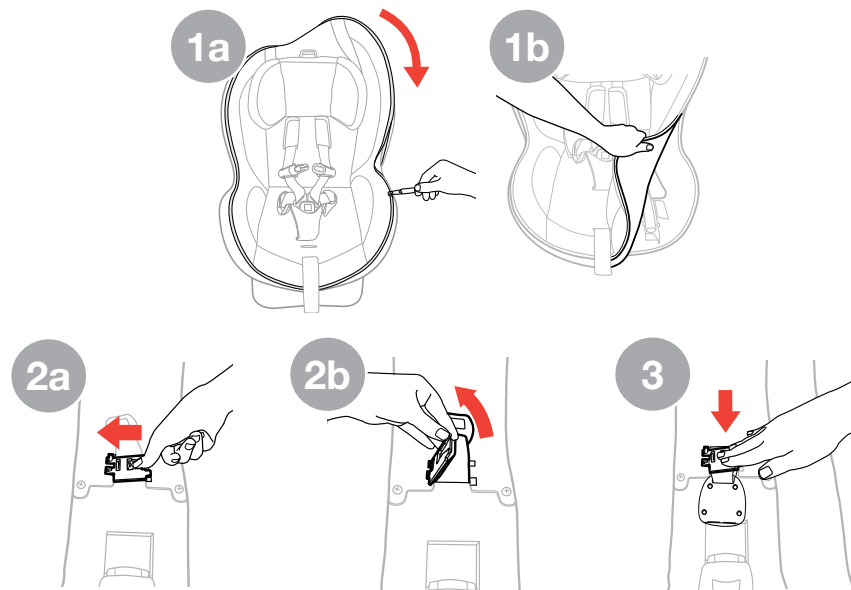

## NEWBORN POSITIONER

**⚠ WARNING** - ONLY use the newborn positioner if the child weighs between 4 and 11 lbs (1.8 and 5 kg).

To ensure a better fit for smaller infants the Newborn Positioner may be needed. Do NOT use any other infant insert or pillows. Only use the one provided by Chicco for this Child Restraint.

*Remove Crotch Strap Pad before installing Newborn Positioner. Refer to page 96.*

- 1 Pull Harness Buckle through slot in the bottom of Newborn Positioner.
- 2 Pull both Harness Straps over the side panels of Newborn Positioner.
- 3 Push Newborn Positioner firmly into Child Restraint(a) to make sure it is properly positioned (b).

## NEWBORN POSITIONER

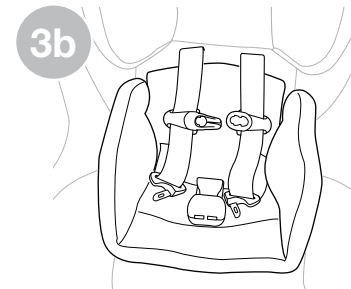
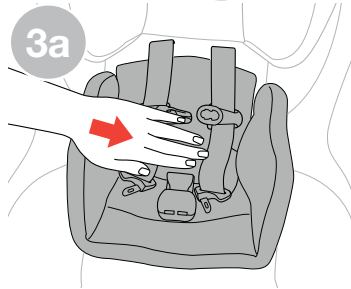
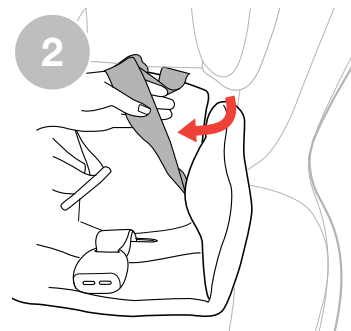
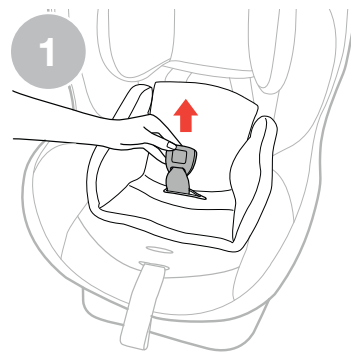



## NEWBORN HEADREST

**⚠ WARNING** - ONLY use the newborn headrest if the child weighs between 4 and 11 lbs (1.8 and 5 kg).

To ensure a better fit for smaller infants the Newborn Headrest may be needed. Do NOT use any other infant insert or pillows. Only use the one provided by Chicco for this Child Restraint.

- 1 Place the Newborn Headrest on the Headrest and fold the backrest fabric up over the Newborn Headrest.
- 2 Pull the elastic Straps down on either side of the fabric attaching the backrest pad to the headrest pad, as shown.
- 3 Connect the elastic Hook to the Strap.
- 4 Replace the backrest pad and harness straps.

## NEWBORN HEADREST

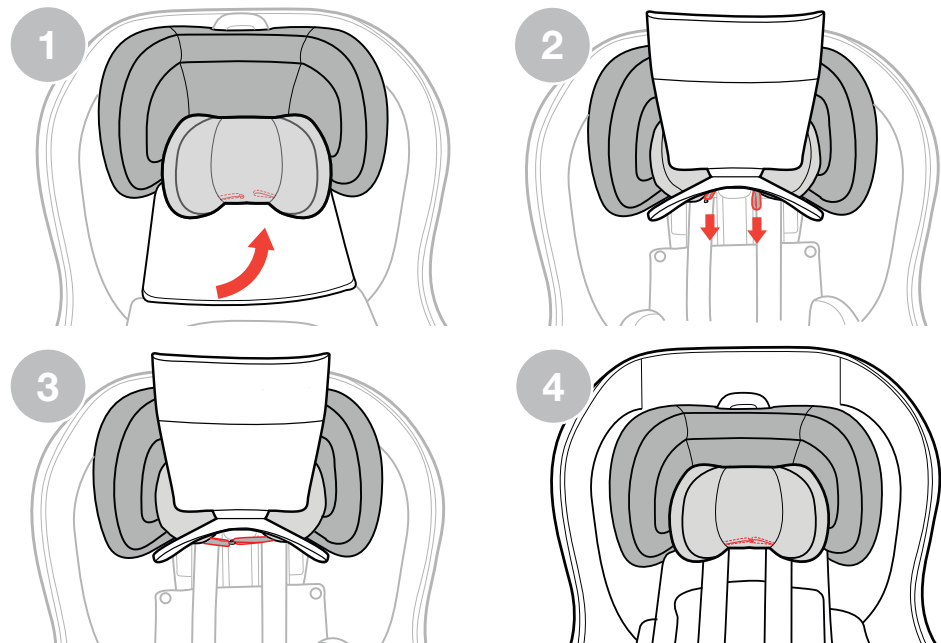

## VEHICLE SEATING POSITIONS



**▲ WARNING! WHEN USING THIS CHILD RESTRAINT REAR-FACING, DO NOT PLACE THIS CHILD RESTRAINT IN A VEHICLE SEATING LOCATION WITH A FRONTAL AIR BAG, UNLESS THE AIR BAG CAN BE TURNED OFF.**

The back seat is the safest place for children 12 and under. See your vehicle owner's manual for Child Restraint installation and instructions.

## VEHICLE SEATING POSITIONS

Some vehicles have no seating positions which are compatible with this Child Restraint. If in doubt, contact the vehicle manufacturer for assistance. Only forward-facing vehicle seats can be used with this Child Restraint.

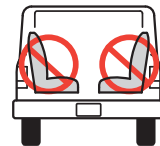

Make sure no more than 3 inches of the Child Restraint base is past the edge of the vehicle seat.

Do not use on a folded down vehicle seat back.

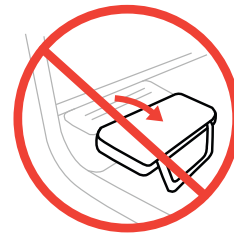

*The information in this section applies to installation with vehicle seat belts only.*

**For simplest installation use LATCH - Refer to page 36 for details.**

Vehicle seat belts differ from vehicle to vehicle. Refer to your vehicle owner's manual for specific information about seat belts and their use with Child Restraints.

**Shoulder belt with switchable retractor:**

Putting the shoulder belt in the locked/switched mode as the last step is optional. The shoulder belt Lock-Off replaces the need for the locked/switched mode. When the Child Restraint is rear-facing using the locked/switched mode may cause Child Restraint to tilt.

**The following types of vehicle belts MUST NOT be used to install this Child Restraint.** If any of the belt types listed below are in the chosen seating position, choose another vehicle seating position or use LATCH if available.

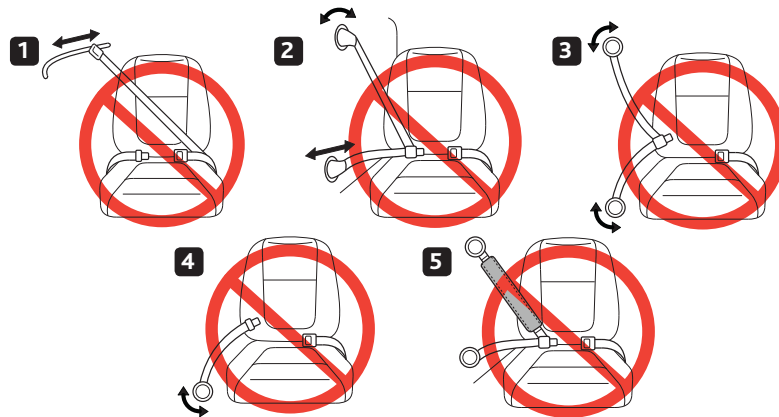

1. Motorized (automatic) vehicle belts.
2. Door mounted vehicle belts.
3. Lap-shoulder Belts with 2 retractors (unless Lap Belt has a "Lock Mode").
4. Non-Locking (ELR) Lap Belts.
5. Inflatable seat belts.

**⚠ WARNING:** This Child Restraint is designed to be used with lower anchors at the standard spacing (11 inches) **ONLY!** Refer to vehicle owner's manual for information about LATCH and Child Restraint installation positions.

### LATCH = Lower Anchors and Tethers for Children

United States Motor Vehicle Safety Standards have defined a system for installing Child Restraints in vehicles called LATCH. **LATCH may ONLY be used IN PLACE OF vehicle belt if the vehicle is equipped with LATCH anchor points. DO NOT use both the seat belt and LATCH at the same time. Please refer to the vehicle owner's manual for designated LATCH locations in vehicles.**

**LATCH** in the vehicle consists of a top tether anchor point and two lower anchor points. Some vehicles owner's manual use the term "**ISOFIX**". **LATCH** can also be used in vehicle seating positions equipped with **ISOFIX**.

If the vehicle is equipped with **LATCH**, the vehicle lower anchor points may be visible at the seat crease. If not visible, the seating position may be marked with a symbol (fig. a) or a colored dot. Check the vehicle owner's manual for vehicle top tether anchor locations. They may be identified using one of the anchor symbols (fig. b or fig. c).

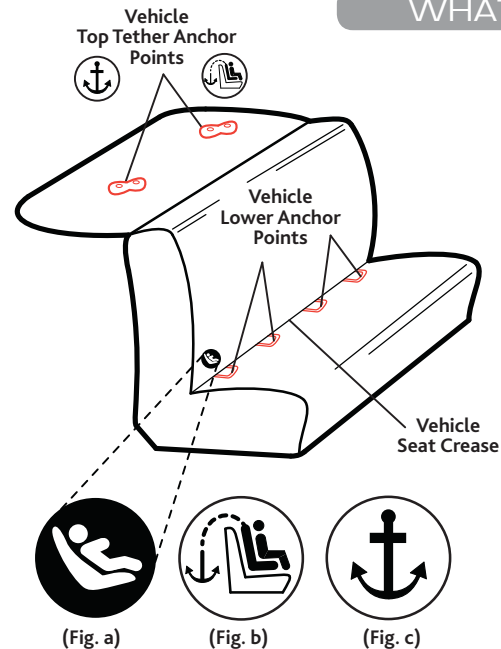

## WHAT IS A TETHER?



The tether is a strap on your child restraint that connects to a tether anchor in your vehicle. Tether anchor locations vary from vehicle to vehicle. Check your vehicle owner's manual and look for the tether anchor symbol as shown. A tether reduces movement of a forward-facing Child Restraint in a crash and helps to achieve a tight installation.

**Vehicle tether anchors can be found in many different locations. Some of the typical locations are shown on the next page. Refer to your vehicle owner's manual for exact locations, anchor identification, and requirements.**

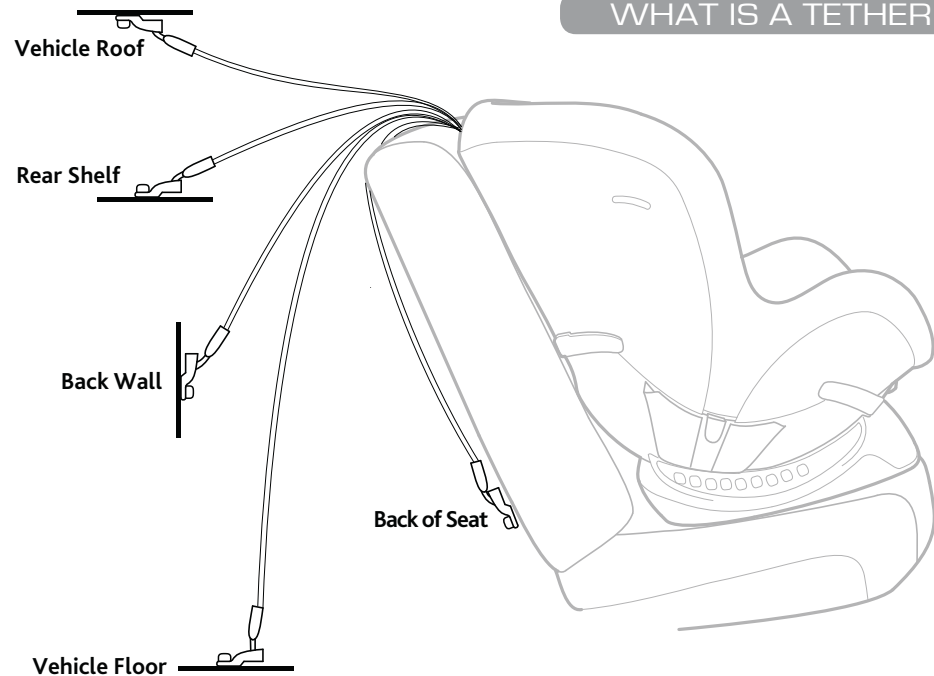

## WHAT IS A TETHER?

## REAR-FACING SETUP

⚠ Infants may have difficulty breathing when in a sitting position. Make sure the seat is reclined properly so that your child's head does not fall forward. **Failure to properly recline the Child Restraint could increase the child's risk of serious injury or death.**

- 1 See page 32 for "Vehicle Seating Positions" before installing. Make sure the vehicle is on a level surface, if possible.



- 2 Squeeze the Recline Adjustment Handle on front of Child Restraint and pull forward to adjust to a reclined position as shown (a).



If a change in recline position is necessary after child restraint is installed, loosen the current method of installation and adjust the recline. Repeat installation steps and refer to pages 42-57 to ensure child restraint is installed correctly.

## REAR-FACING SETUP

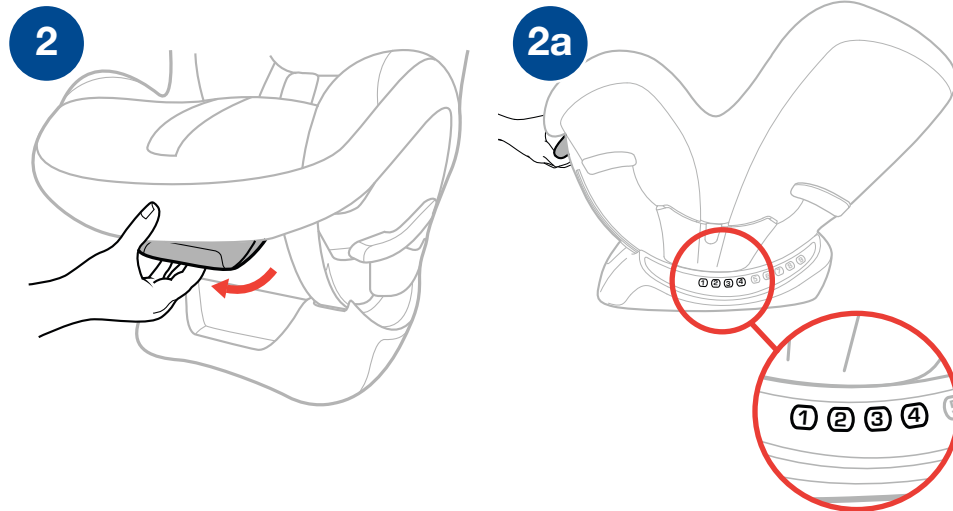
Do not use Tether in REAR-FACING mode. Tether must be properly stored - See "Tether Storage" page 20.



## REAR-FACING SETUP

- 3** Place Child Restraint rear-facing on selected vehicle seat. Make sure it is not blocking the vehicle belt buckle. Do not exceed the rear-facing maximum overhang of 3 inches over the front edge of the vehicle seat.
- 4**  **Installation on a Level Surface:** Locate the Bubble Level Indicator label and re-adjust the seat recline to any position that the Bubble falls between the lines for **REAR-FACING** installation.
-  **Installation on a Slope:** Locate the level line on the blue label near the rear-facing belt path. Adjust the seat recline so that the level line is level with the ground.

**Installation Options:**

- *LATCH installation continued on page 44.*
- *Lap-Shoulder Belt installation continued on page 50.*
- *Lap Belt Only installation continued on page 54.*

## REAR-FACING SETUP

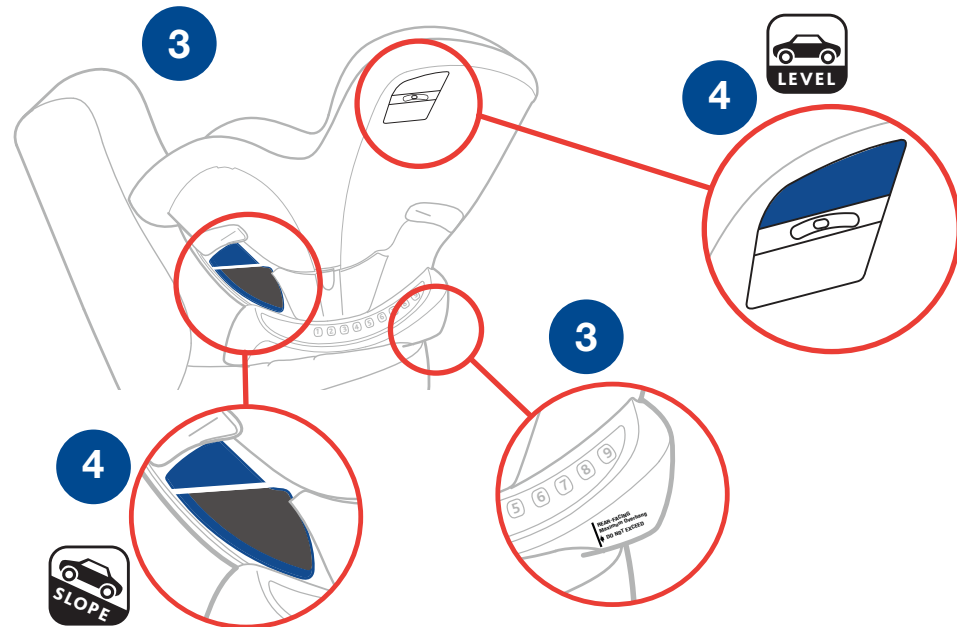

## INSTALL USING LATCH

⚠ Do not use the lower anchors of the Child Restraint anchorage system (LATCH system) to attach this Child Restraint when restraining a child weighing more than **35 lbs (15.9 kg)** with the internal harness of the Child Restraint.

⚠ When installing with LATCH in vehicle equipped with inflatable seat belts, the unused seat belt should NOT be buckled behind the Child Restraint System as this will engage the inflatable portion of the belt.

- 1 Locate the LATCH Connector Storage compartments. Remove LATCH straps. Make sure SuperCinch® LATCH Tightener strap (Pull 2<sup>nd</sup>) and LATCH Adjuster strap (Pull 1<sup>st</sup>) are loosened to their full length.

## INSTALL USING LATCH

Make sure LATCH Adjuster strap (Pull 1<sup>st</sup>) is loosened to the full length.

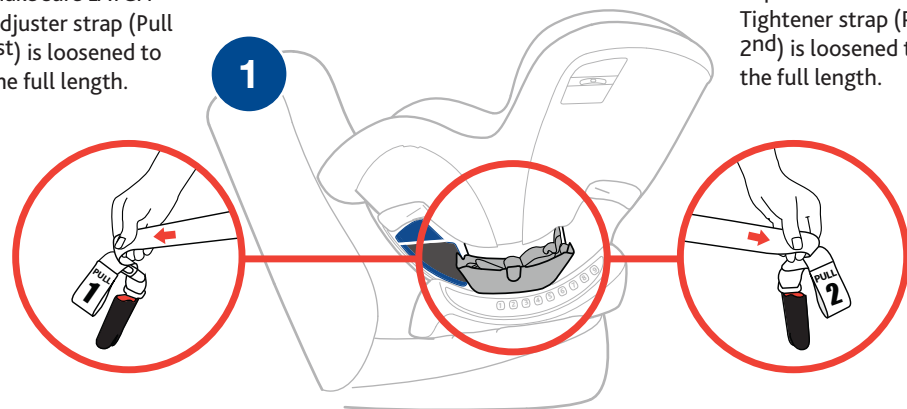

Make sure SuperCinch® LATCH Tightener strap (Pull 2<sup>nd</sup>) is loosened to the full length.



## INSTALL USING LATCH

- 2 Grab both ends of LATCH straps. Slide LATCH strap to blue REAR-FACING opening on both sides. Note: Both LATCH Connector Storage compartments must be open and both LATCH straps must be loosened to their full length in order to slide LATCH straps into position.
- 3 Close both LATCH Connector Storage compartments.

⚠ When not accessing the LATCH or changing the belt path **ALWAYS** keep LATCH Connector Storage compartments closed.

## INSTALL USING LATCH

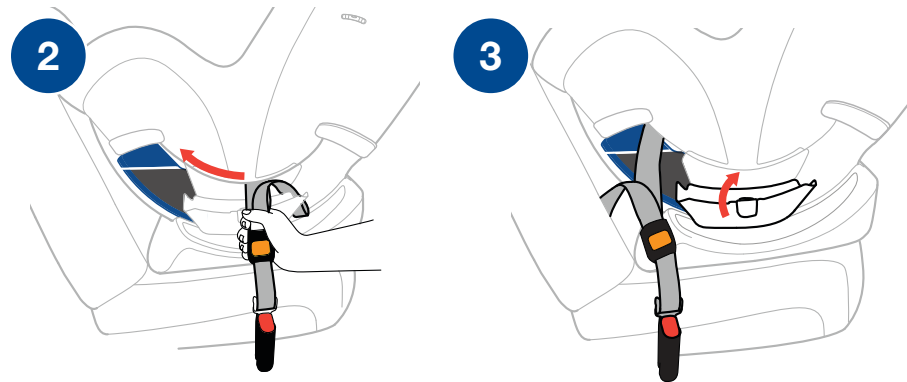

## INSTALL USING LATCH

- 4 Locate the LATCH anchor bars in your vehicle. Attach both LATCH Connectors to the vehicle LATCH bars.
- 5 Pull up on the end of the LATCH Adjuster strap (Pull 1<sup>st</sup>) until strap is tight.
- 6 Pull on the SuperCinch® LATCH Tightener strap (Pull 2<sup>nd</sup>) to secure the Child Restraint.

## CHECK YOUR WORK

- ✓ Hold Child Restraint at each side near REAR-FACING vehicle belt paths. Pull side to side and forward. Child Restraint should not move more than 1" (25 mm) from vehicle seat back or side-to-side.
- ✓ Make sure Child Restraint is level for REAR-FACING use. Make sure infant's head does not fall forward. If necessary, loosen the Latch Strap, re-adjust recline and repeat installation steps to make sure Child Restraint is installed properly.
- ✓ Check installation before every use!

## INSTALL USING LATCH

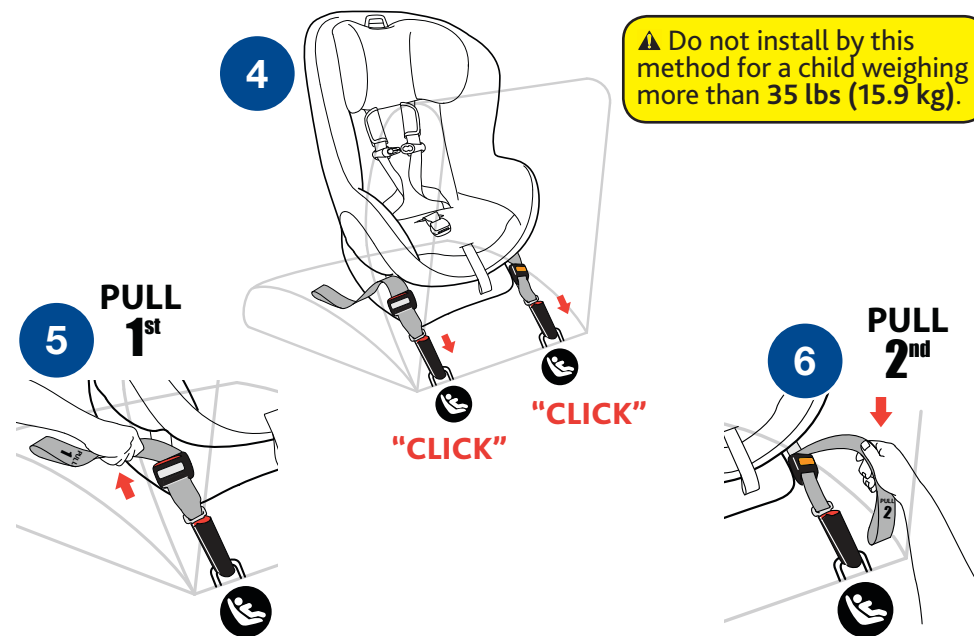

## INSTALL USING LAP-SHOULDER BELT

- 1 Unzip seat pad.
- 2 Route vehicle lap-shoulder belt through the blue **REAR-FACING** seat belt path on the side of Child Restraint (a). Pull seat pad to the side and route the vehicle lap-shoulder belt through the blue **REAR-FACING** seat belt path on the side of Child Restraint (b).
- 3 Route the vehicle belt **UNDER** the seat pad (a). Vehicle belt must be routed behind the Crotch Strap when the Crotch Strap is in the forward position (closest to the Harness Release Button) or in front of the Crotch Strap when it is in the rear position.

Pull vehicle belt down through the blue **REAR-FACING** seat belt path on opposite side of Child Restraint. Buckle the vehicle belt (b). Then re-attach the zippered seat pad.

## INSTALL USING LAP-SHOULDER BELT

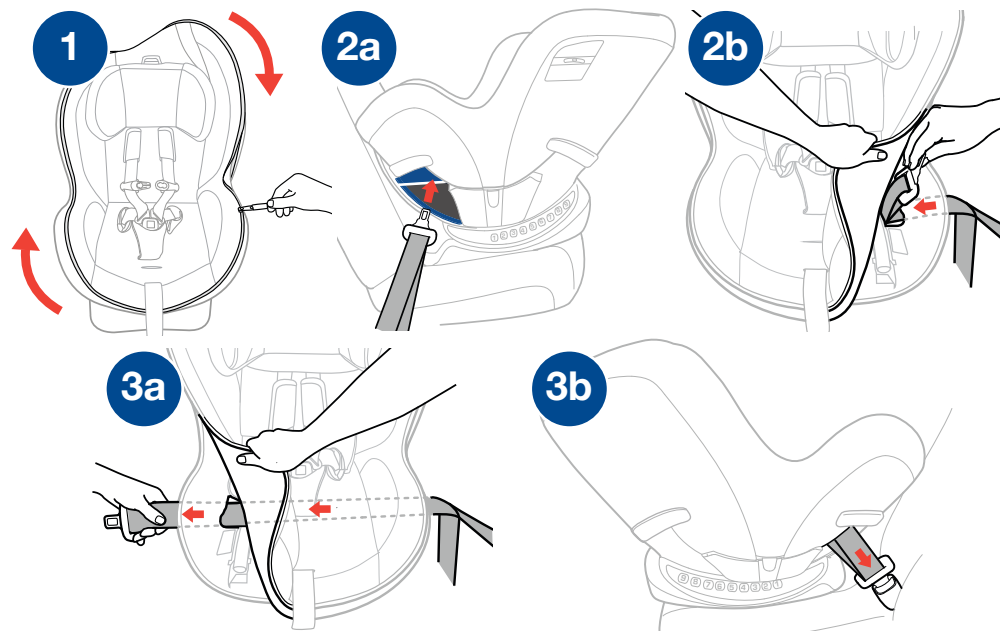

## INSTALL USING LAP-SHOULDER BELT

- 4 While pushing down on the Child Restraint (a) pull the vehicle shoulder belt (b) to tighten vehicle lap belt.
- 5 While still pulling the shoulder belt tight, slide the vehicle shoulder belt into the Lock-Off. Always use the Lock-Off on the opposite side of the vehicle belt buckle.

## CHECK YOUR WORK

- ✓ Hold Child Restraint at each side near REAR-FACING vehicle belt paths. Pull side to side and forward. Vehicle belt should remain tight and Child Restraint should not move more than 1" (25 mm) from vehicle seat back or side-to-side.
- ✓ Make sure Child Restraint is level for REAR-FACING use. Make sure infant's head does not fall forward. If necessary, loosen the vehicle belt, re-adjust recline and repeat installation steps to make sure Child Restraint is installed properly.
- ✓ Check installation before every use!

## INSTALL USING LAP-SHOULDER BELT

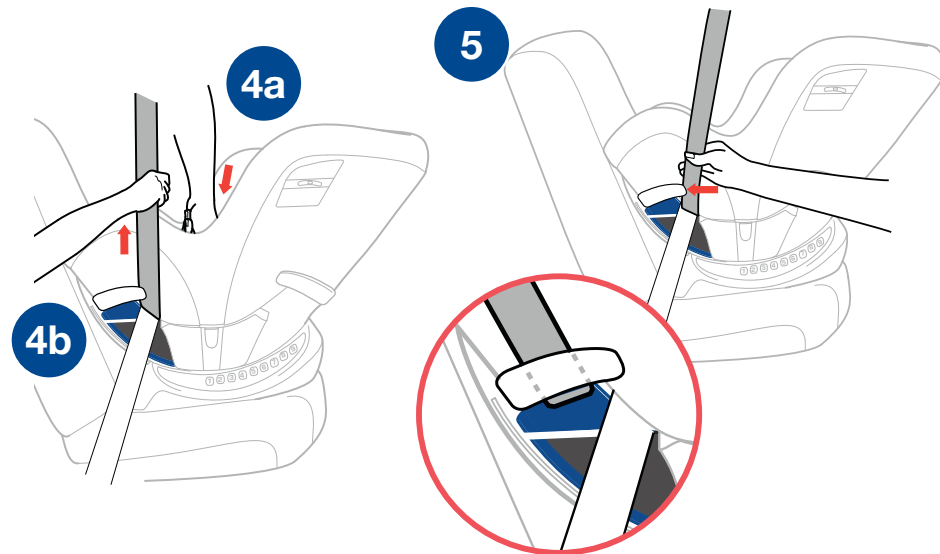

## INSTALL USING LAP BELT ONLY

- 1 Unzip seat pad.
- 2 Route vehicle lap-shoulder belt through the blue **REAR-FACING** seat belt path on the side of Child Restraint (a). Pull seat pad to the side and route the vehicle lap-shoulder belt through the blue **REAR-FACING** seat belt path on the side of Child Restraint (b).
- 3 Route the vehicle belt **UNDER** the seat pad (a). Vehicle belt must be routed behind the Crotch Strap when the Crotch Strap is in the forward position (closest to the Harness Release Button) or in front of the Crotch Strap when it is in the rear position.

Pull vehicle belt down through the blue **REAR-FACING** seat belt path on opposite side of Child Restraint. Buckle the vehicle belt (b). Then re-attach the zippered seat pad.

## INSTALL USING LAP BELT ONLY

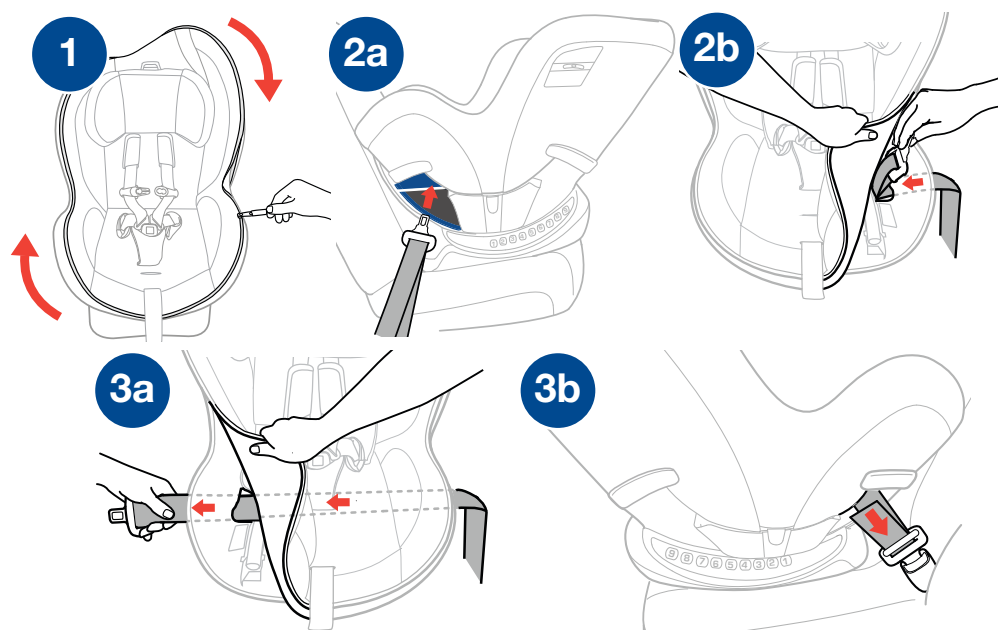

## INSTALL USING LAP BELT ONLY

- 4 While pushing down on the Child Restraint (a) pull the loose end of the vehicle lap belt (b) to tighten belt.

## CHECK YOUR WORK

- ✓ Hold Child Restraint at each side near REAR-FACING vehicle belt paths. Pull side to side and forward. Vehicle belt should remain tight and Child Restraint should not move more than 1" (25 mm) from vehicle seat back or side-to-side.
- ✓ Make sure Child Restraint is level for REAR-FACING use. Make sure infant's head does not fall forward. If necessary, loosen the vehicle belt, re-adjust recline and repeat installation steps to make sure Child Restraint is installed properly.
- ✓ Check installation before every use!

## INSTALL USING LAP BELT ONLY

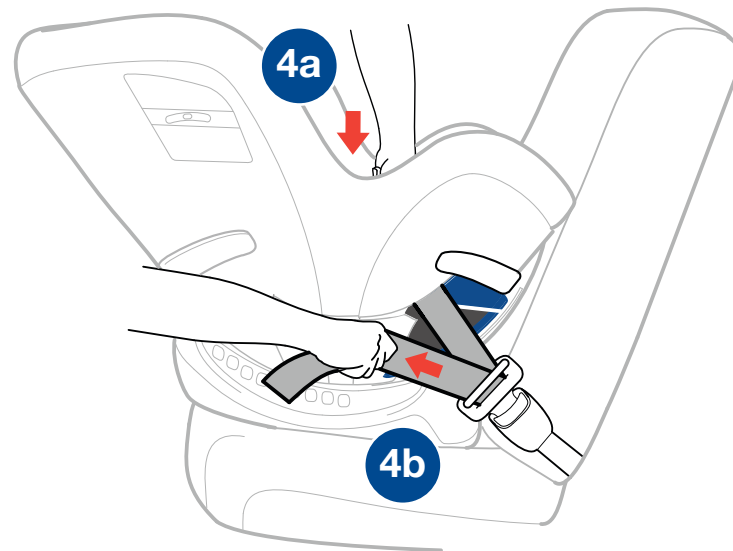

## FORWARD-FACING SETUP

- 1 Before placing the Child Restraint in the vehicle, remove Tether from the tether compartment. You may need to squeeze the Tether Button and pull down to loosen the strap before removing. If a tether anchor is not available, the Tether should be stored properly.
- 2 See page 32 for "Vehicle Seating Positions" before installing. Make sure the vehicle is on a level surface, if possible.



- 3 Squeeze the Recline Adjustment Handle on front of Child Restraint and push back to adjust to an upright position as shown (a).

If a change in recline position is necessary, after Child Restraint is installed, loosen the current method of installation and adjust the recline. Repeat installation steps and refer to pages 60-77 to ensure Child Restraint is installed correctly.

## FORWARD-FACING SETUP

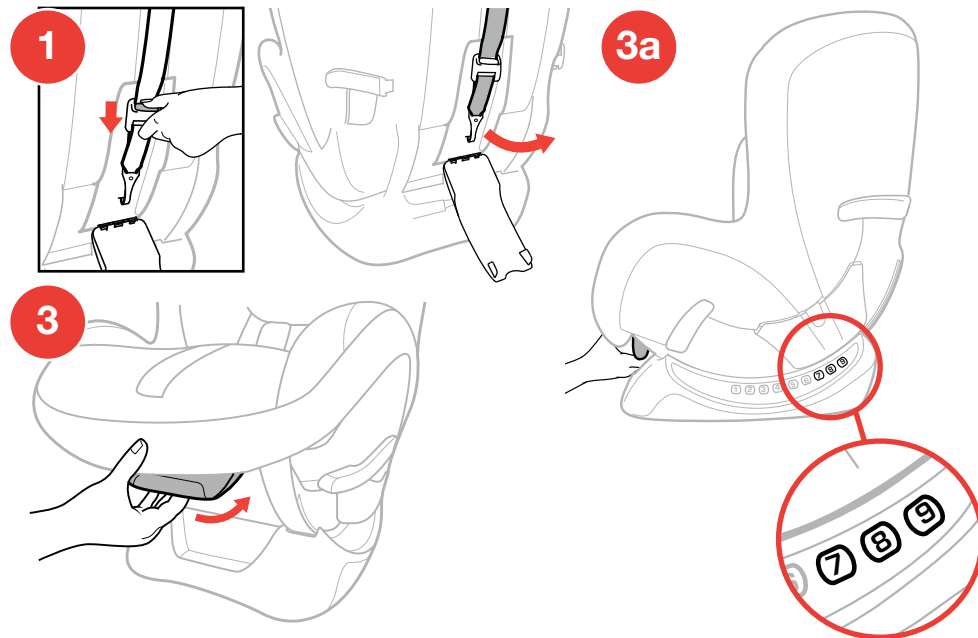

## FORWARD-FACING SETUP

**4** Place Child Restraint facing forward on selected vehicle seat. Make sure it is not blocking the vehicle belt buckle. Lay Tether Strap over the back of the vehicle seat.

**5**  **Installation on a Level Surface:** Locate the Bubble Level Indicator label and re-adjust the seat recline to any position that the Bubble falls between the lines for **FORWARD-FACING** installation.

 **Installation on a Slope:** If vehicle is on a slope adjust the seat recline to position 8 or 9 **ONLY**.

**Installation Options:**

- *LATCH installation continued on page 62.*
- *Lap-Shoulder Belt installation continued on page 68.*
- *Lap Belt Only installation continued on page 74.*

## FORWARD-FACING SETUP

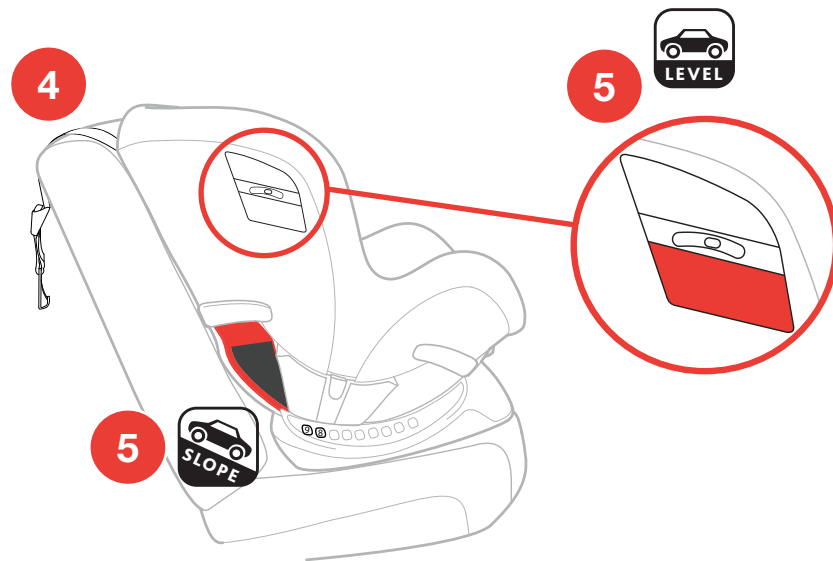



## INSTALL USING LATCH

⚠ Do not use the lower anchors of the Child Restraint anchorage system (LATCH system) to attach this Child Restraint when restraining a child weighing more than **40 lbs (18 kg)** with the internal harness of the Child Restraint.

⚠ When installing with LATCH in vehicle equipped with inflatable seat belts, the unused seat belt should NOT be buckled behind the Child Restraint System as this will engage the inflatable portion of the belt.

- 1 Locate LATCH Connector Storage compartments. Remove LATCH straps. Make sure SuperCinch® LATCH Tightener strap (Pull 2<sup>nd</sup>) and LATCH Adjuster strap (Pull 1<sup>st</sup>) are loosened to their full length.
- 2 Grab both ends of LATCH straps. Slide LATCH strap to red **FORWARD-FACING** opening on both sides. Note: Both LATCH Connector Storage compartments must be open and both LATCH straps must be loosened to their full length in order to slide LATCH straps into position.
- 3 Close both LATCH Connector Storage compartments.

## INSTALL USING LATCH

Make sure SuperCinch® LATCH Tightener strap (Pull 2<sup>nd</sup>) is loosened to the full length.

1



Make sure LATCH Adjuster strap (Pull 1<sup>st</sup>) is loosened to the full length.

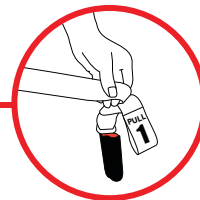

2

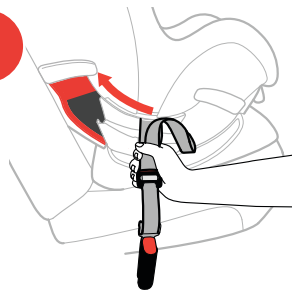

3

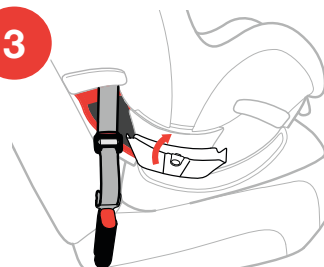

## INSTALL USING LATCH

⚠ When not accessing the LATCH or changing the belt path **ALWAYS** keep LATCH Connector Storage compartments closed.

- 4 Locate the LATCH bars in your vehicle. Attach both LATCH Connectors to the vehicle LATCH anchor bars.
- 5 Pull up on the end of the LATCH Adjuster strap (Pull 1<sup>st</sup>) until strap is tight.
- 6 Pull on the SuperCinch® LATCH Tightener strap (Pull 2<sup>nd</sup>) to secure Child Restraint.

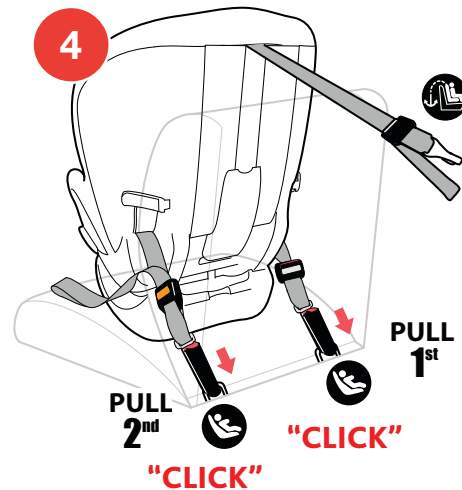

⚠ Do not install by this method for a child weighing more than 40 lbs (18 kg).

## INSTALL USING LATCH

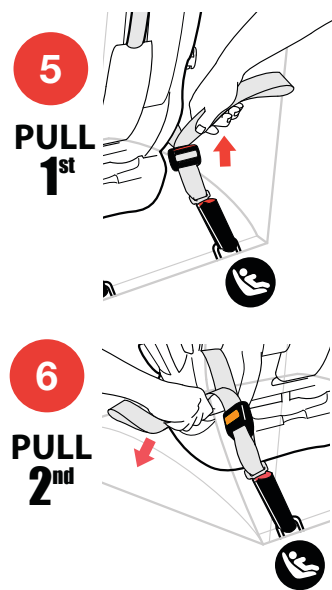

## INSTALL USING LATCH

- 7** Locate Tether anchor in your vehicle. Attach Tether Hook. Pull Tether Adjuster strap to tighten.

## CHECK YOUR WORK

- ✓ Hold Child Restraint at each side near FORWARD-FACING vehicle belt path. Pull side to side and forward. Child Restraint should not move more than 1" (25 mm) from vehicle seat back or side-to-side.
- ✓ Make sure Bubble is between lines on label for FORWARD-FACING use. If necessary, loosen the LATCH and Tether Straps, re-adjust recline and repeat installation steps to make sure Child Restraint is installed properly.
- ✓ Check installation before every use!

## INSTALL USING LATCH

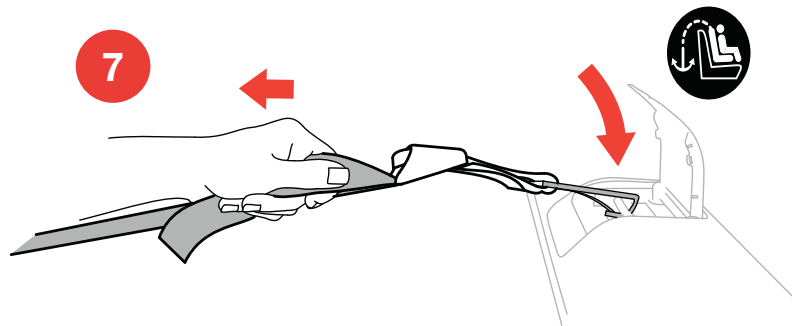

## INSTALL USING LAP-SHOULDER BELT

- 1 Route vehicle lap-shoulder belt through the red **FORWARD-FACING** seat belt path on the side of Child Restraint. Lift the padding on the back of the seat and pull the vehicle belt through the opening on the side of Child Restraint.
- 2 Pass the vehicle belt along the back of the Child Restraint as shown.
- 3 Pull the vehicle belt down through the red **FORWARD-FACING** seat belt path on the opposite side of Child Restraint. Buckle the vehicle belt. Replace the seat back padding.

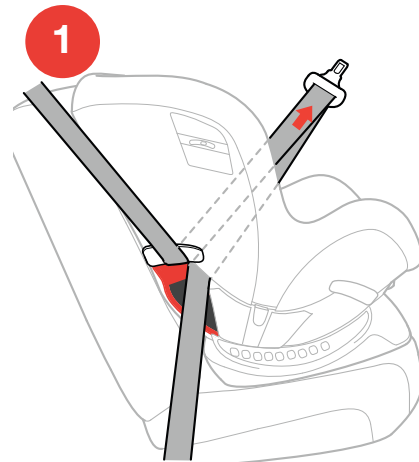

## INSTALL USING LAP-SHOULDER BELT

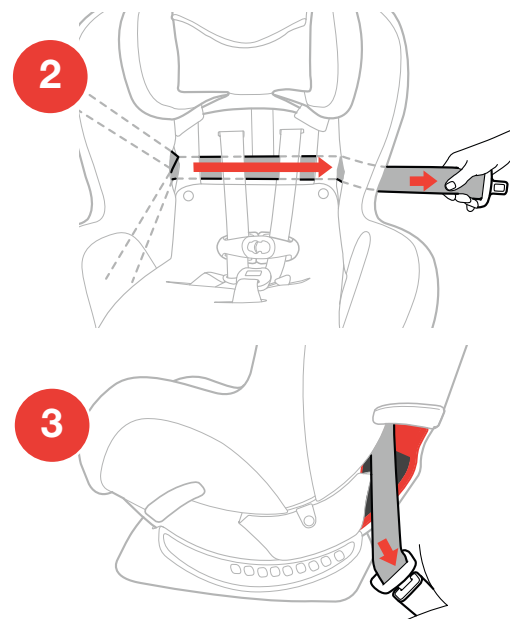

## INSTALL USING LAP-SHOULDER BELT

- 4 While pushing down on the Child Restraint (a) pull the vehicle shoulder belt (b) to tighten vehicle lap belt.
- 5 While still pulling the shoulder belt tight, slide the vehicle shoulder belt into the Lock-Off. Always use the Lock-Off on the opposite side of the vehicle belt buckle.

## INSTALL USING LAP-SHOULDER BELT

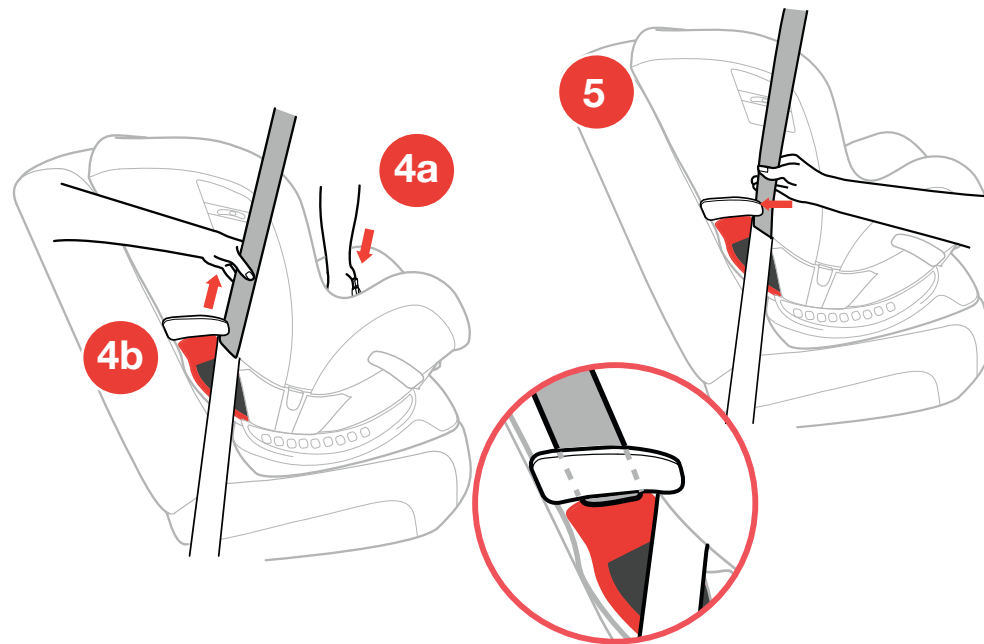

## INSTALL USING LAP-SHOULDER BELT

- 6** Locate Tether anchor in your vehicle. Attach Tether Hook. Pull Tether Adjuster strap to tighten.

## CHECK YOUR WORK

- ✓ Hold Child Restraint at each side near FORWARD-FACING vehicle belt path. Pull side to side and forward. Vehicle belt should remain tight and Child Restraint should not move more than 1" (25 mm) from vehicle seat back or side-to-side.
- ✓ Make sure Bubble is between lines on label for FORWARD-FACING use. If necessary, loosen the vehicle belt and Tether, re-adjust recline and repeat installation steps to make sure Child Restraint is installed properly.
- ✓ Check installation before every use!

## INSTALL USING LAP-SHOULDER BELT

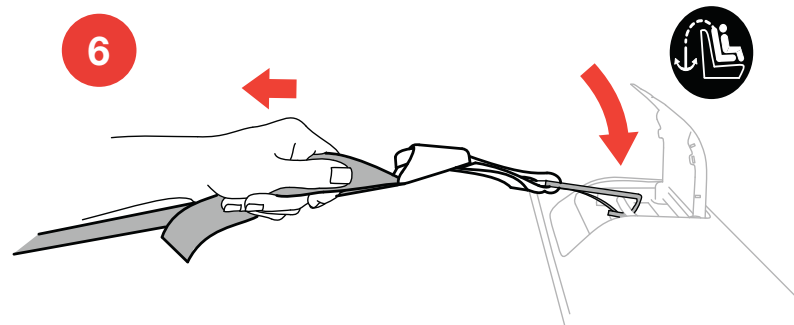

## INSTALL USING LAP BELT ONLY

- 1 Route vehicle lap belt through the red **FORWARD-FACING** seat belt path on the side of Child Restraint. Lift the padding on the back of the seat and pull the vehicle belt through the opening on the side of the Child Restraint.
- 2 Pass the vehicle belt along the back of the Child Restraint as shown.
- 3 Pull the vehicle belt down through the red **FORWARD-FACING** seat belt path on the opposite side of Child Restraint. Buckle the vehicle belt. Replace the seat back padding.

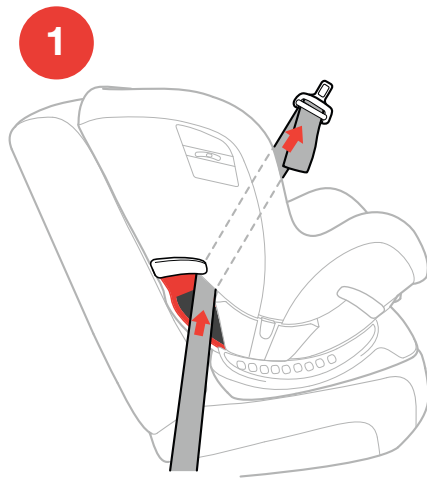

## INSTALL USING LAP BELT ONLY

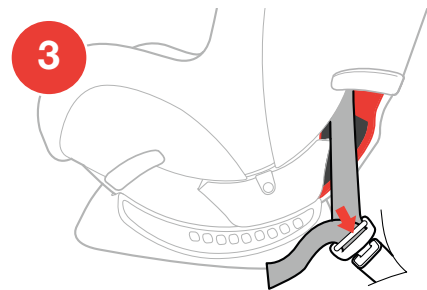
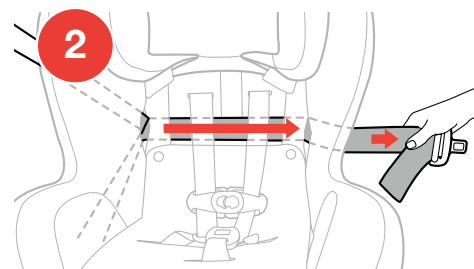

## INSTALL USING LAP BELT ONLY

- 4 While pushing down on the Child Restraint (a) pull the loose end of the vehicle lap belt (b) to tighten.
- 5 Locate Tether anchor in your vehicle. Attach Tether Hook. Pull Tether Adjuster strap to tighten.

## CHECK YOUR WORK

- ✓ Hold Child Restraint at each side near FORWARD-FACING vehicle belt path. Pull side to side and forward. Vehicle belt should remain tight and Child Restraint should not move more than 1" (25 mm) from vehicle seat back or side-to-side.
- ✓ Make sure Bubble is between lines on label for FORWARD-FACING use. If necessary, loosen the vehicle belt and Tether, re-adjust recline and repeat installation steps to make sure Child Restraint is installed properly.
- ✓ Check installation before every use!

## INSTALL USING LAP BELT ONLY

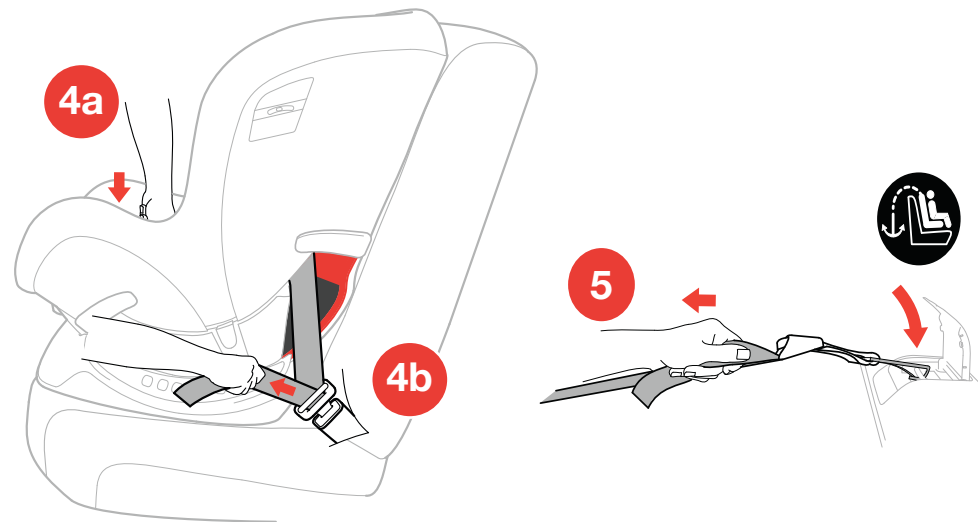



## SECURING CHILD WITH HARNESS

*For a better fit in the Child Restraint with smaller infants, the Newborn Positioner and Newborn Headrest provided may be needed. See page 28-31 for more details. Additionally, waist belt pads, crotch strap pad, and shoulder pads may need to be removed.*

*If Crotch Strap is under child, the crotch strap will need to be re-positioned, refer to page 26 "Adjusting Crotch Strap".*

- 1** Loosen Harness by pressing Harness Release Button (under the fabric) on the front of the Child Restraint and pulling forward on both of the Harness Straps.
- 2** Unbuckle Harness by pressing the button on Harness Buckle and pulling out both Buckle Tongues.
- 3** Open Chest Clip by squeezing both button in the middle of the clip and pulling apart.

## SECURING CHILD WITH HARNESS

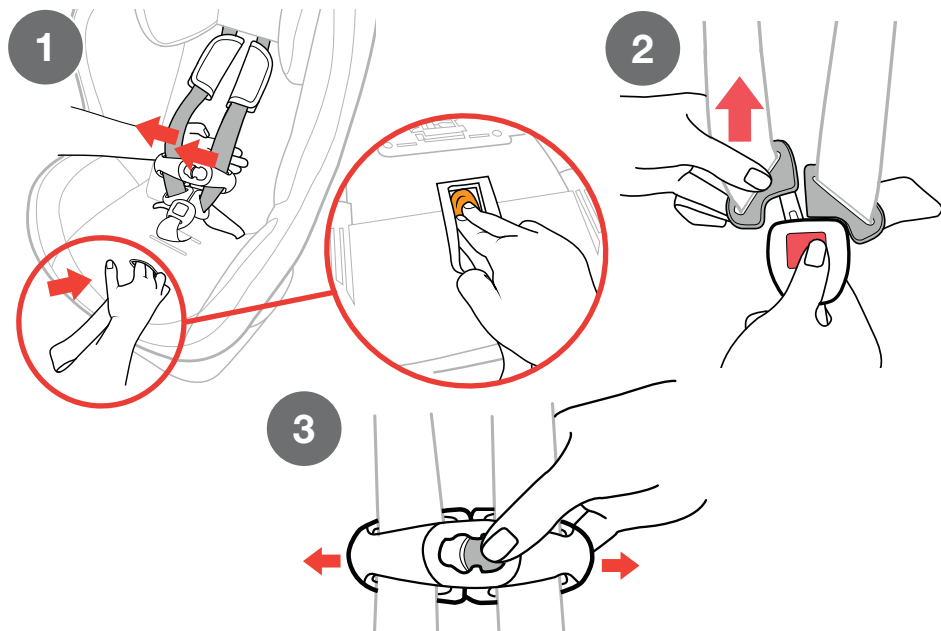

## SECURING CHILD WITH HARNESS

- 4 Place child in Child Restraint with child's back flat against the back of the seat. Pull Harness Straps over the child's shoulders and around the child's waist. Make sure there are no twists in Harness Strap.

*Clothing, such as bulky winter coats that interfere with the proper placement or adjustment of the Harness system should never be used. Make sure the Harness Straps lie flat on the child's shoulders, are adjusted snugly so that clothing is compressed and the child cannot lean forward, and the Chest Clip is at arm level.*

## SECURING CHILD WITH HARNESS

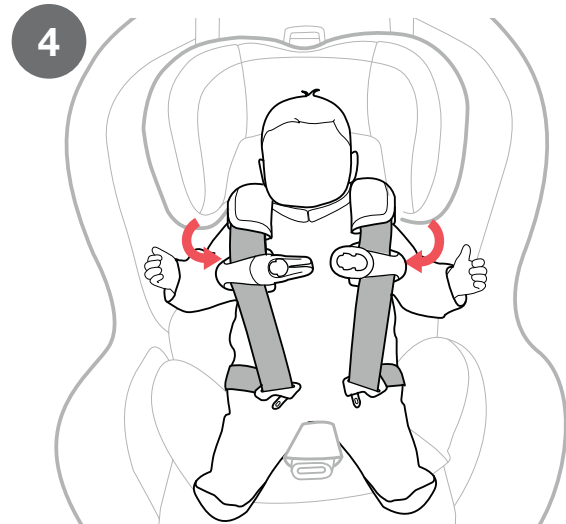

## SECURING CHILD WITH HARNESS

- 5 Adjust Harness Strap height position up or down by squeezing Adjustment Handle on top of Head Rest. Make sure Head Rest locks into position before tightening Harness.

**REAR-FACING POSITION** - Position the Harness Straps at or below the child's shoulders.

**FORWARD-FACING POSITION** - Position the Harness Straps at or above the child's shoulders.

If using lowest Head Rest/Harness Position, make sure the seat back padding panel is folded under.

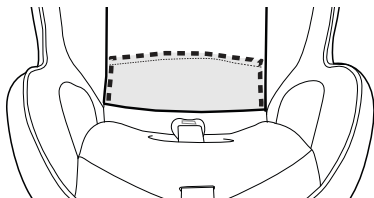

## SECURING CHILD WITH HARNESS

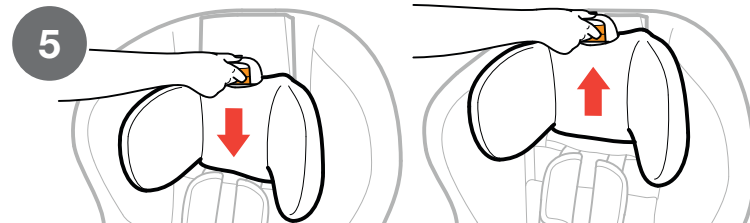

**REAR-FACING  
AT OR BELOW**

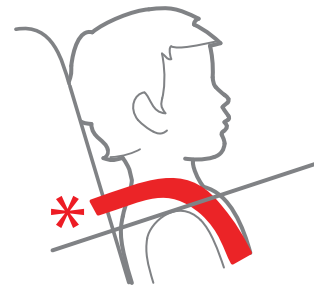

**FORWARD-FACING  
AT OR ABOVE**

## SECURING CHILD WITH HARNESS

- 6 Insert each Buckle Tongue into Harness Buckle; listen for a click (a). Pull up firmly on both Buckle Tongues to make sure that they are securely latched (b).

## SECURING CHILD WITH HARNESS

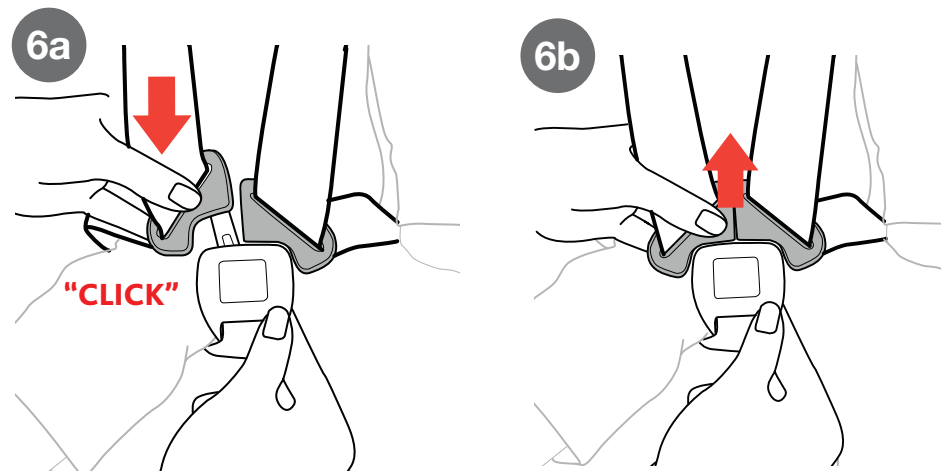

## SECURING CHILD WITH HARNESS

- 7 Fasten Chest Clip by snapping both sides together; listen for a click.

*Harness straps must fit snugly and lay flat on the center of your child's shoulders.*

- 8 Push Chest Clip and Shoulder Pads down away from the child's neck and towards the Harness Buckle. Pull up on both shoulder straps to remove all slack from below.

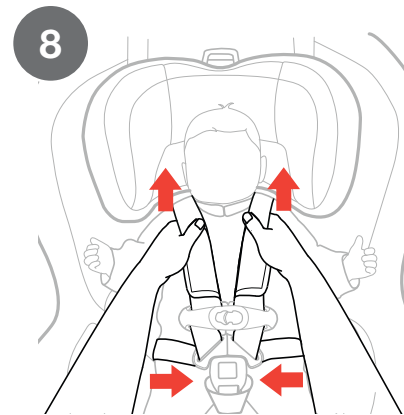
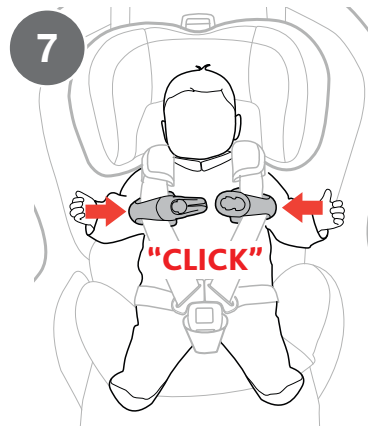

## SECURING CHILD WITH HARNESS

## SECURING CHILD WITH HARNESS

- 9** Tighten the harness by pulling slowly on Harness Adjustment Strap until the harness is snug on child (a). If you can pinch a fold in the strap at the child's shoulders, harness is too loose (b). If the harness is too loose pull the Harness Adjustment strap more.
- 10** Move the Shoulder Pads up to the child's shoulders. Slide Chest Clip up to center of child's chest, level with the armpits.

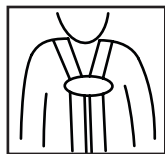

**⚠ WARNING** - If harness is not snug around your child, child could be ejected in a sudden stop or crash resulting in serious injury or death.

## SECURING CHILD WITH HARNESS

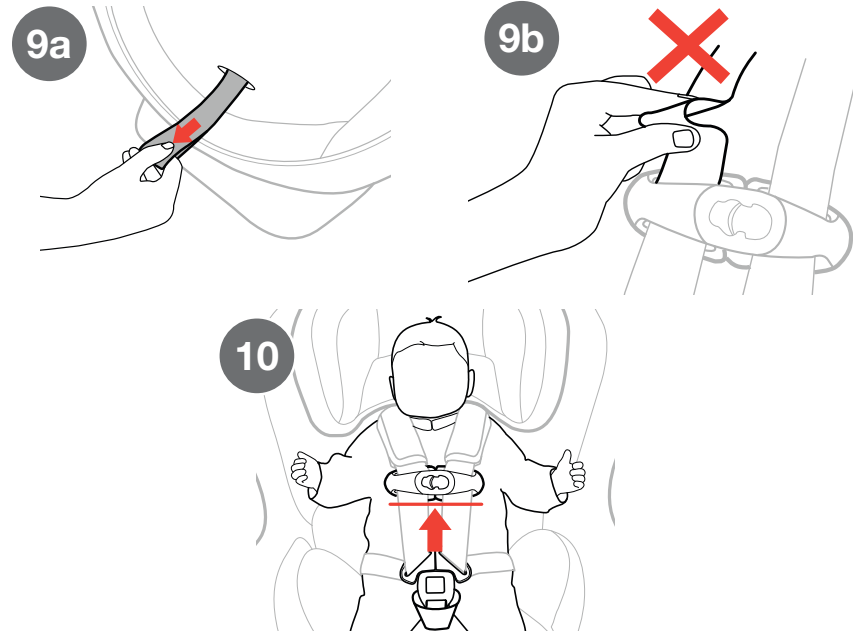

## SECURING CHILD CHECKLIST

- ✓ Harness Straps must be snug. If you can pinch a fold in the strap, the harness is too loose. A snug strap should not allow any slack. It lies in a relatively straight line without sagging. It does not press on the child's flesh or push the child's body into an unnatural position.

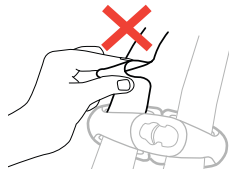

- ✓ To ensure a better fit for smaller infants, the Newborn Positioner and Newborn Headrest may be needed. Never place extra padding under or behind the child. Only use the Newborn Positioner and Newborn Headrest.

- ✓ Straps must lay flat, free of twists and centered on top of the child's shoulders.

- ✓ Check the height of the Harness Straps: Position the Harness Straps at or below the child's shoulders for REAR-FACING and at or above the child's shoulders for FORWARD-FACING.



REAR-FACING



FORWARD-FACING

## SECURING CHILD CHECKLIST

- ✓ Check the position of Chest Clip: Chest Clip should be centered on the child's chest, level with the armpits.
- ✓ Never secure child in Child Restraint with child dressed in bulky garments or heavy clothing. Heavy clothing can prevent harness from being properly tightened around child.
- ✓ Never secure child in Child Restraint with child wrapped in a blanket. To keep child warm, place a blanket over child AFTER you have properly secured and tightened harness around child.

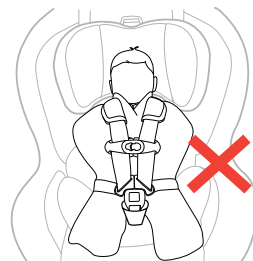

NO Bulky Clothing

**⚠ WARNING** - If harness is not snug around your child, child could be ejected in a sudden stop or crash resulting in serious injury or death.

## INSTALLATION ON AN AIRCRAFT

*When traveling by airplane with your child, Chicco recommends taking the Child Restraint on the airplane with you so that you can use it with your child. Not only will it protect your child during take-off, landing, and turbulence, it will also allow your child to be more comfortable.*

- This Child Restraint is certified for use on aircraft. Contact the airline prior to travel to discuss their Child Restraint policy.
- Install Child Restraint on an aircraft the same way it is installed in a vehicle when using a vehicle lap belt. Reference Rear-Facing on page 54 or Forward-Facing on page 74.

PAGE INTENTIONALLY LEFT BLANK



**▲ WARNING** - Do NOT use Cup Holder to hold hot liquids. PLASTIC CONTAINERS ONLY - No glass or metal containers. Only use cups with less than 12 oz. (355 ml) capacity. Never place sharp or pointed objects in Cup Holder. In a crash these objects could hit you or your child and cause serious injuries.

- 1** Slide Cup Holder into each side of Child Restraint where indicated by the Cup Holder icon.

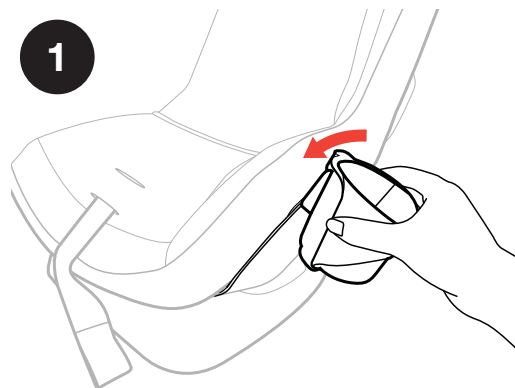

## CLEANING AND MAINTENANCE

**REMOVING SHOULDER PADS:**

- 1** Unhook the hook and loop and remove Shoulder Pads as shown.

**INSTALL SHOULDER PADS:**

- 2** Re-attach Shoulder Pads by folding the hook and loop Tab over the Harness Strap (a). Secure both hook and loop Tabs together (b). Make sure they are oriented as shown (c).

**REMOVING CROTCH STRAP PAD:**

- 3** Locate the Tab on the Crotch Strap Pad and push it through the Harness Buckle (a). Pull the Tab out through the front of the Harness Buckle (b) and remove the Crotch Strap Pad (c).

## CLEANING AND MAINTENANCE

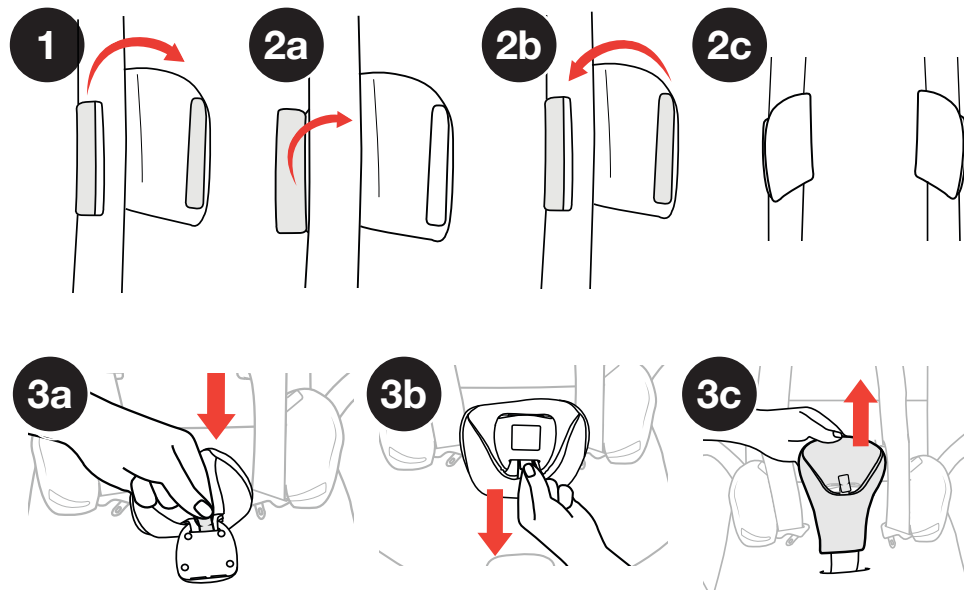

## CLEANING AND MAINTENANCE

**REMOVING SOFTGOODS:**

- 4 Unbuckle the Harness. Unhook the hook and loop on both of the Waist Belt pads (select models).
- 5 Unsnap Seat Bottom Panel and pull forward (b).
- 6 Remove the Waist Belt pads (select models).

## CLEANING AND MAINTENANCE

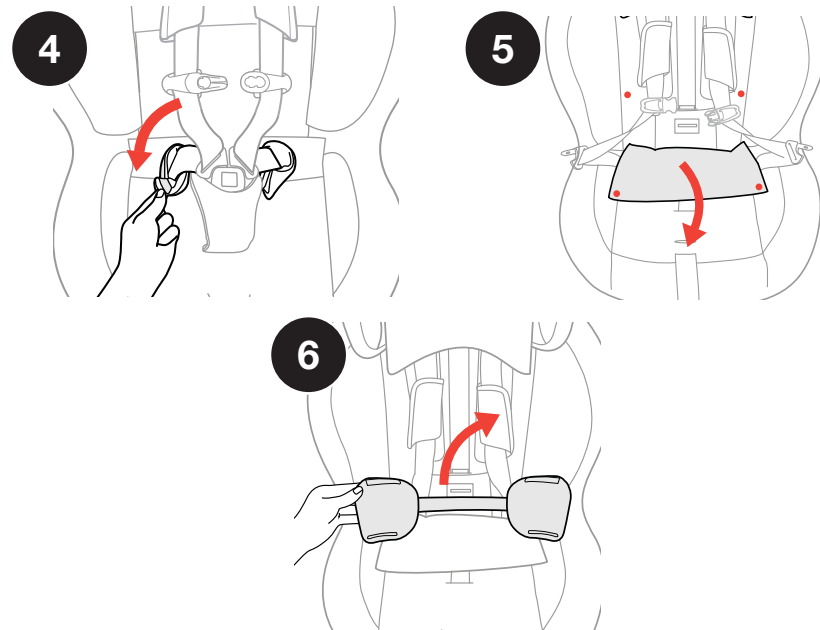

**REMOVING SOFTGOODS:**

- 7 Locate the Zipper Tab at the top of the Child Restraint and unzip all the way around.
- 8 Carefully pull the Seat Pad away from the Child Restraint (b).

**INSTALL SOFTGOODS:**

- 9 Reverse the removing instructions above to reinstall.

⚠ NEVER use Child Restraint without the Seat Pad.

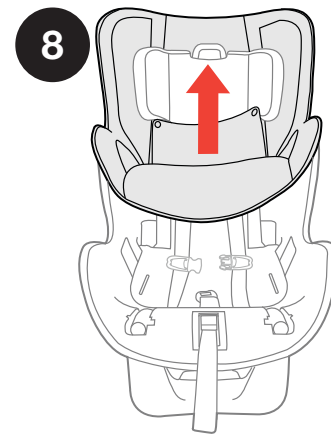
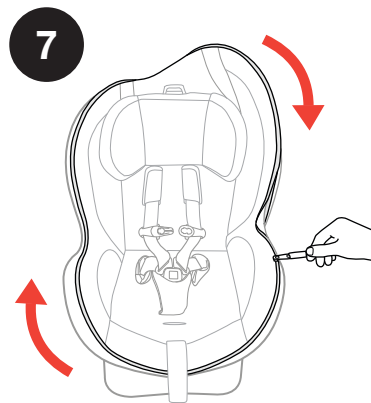

## CLEANING AND MAINTENANCE

**REMOVING CROTCH STRAP:**

- 1 Fully recline the seat (position 1). Open the compartment, slide the button on the Crotch Strap lock while pulling up on the Crotch Strap (a). Turn metal bar slightly on underside of seat and get corner to go through slot (b). Push metal bar through slot while pulling crotch belt out (c).

⚠ NEVER use Child Restraint without the Crotch Strap installed.

**INSTALL CROTCH STRAP:**

- 2 Reverse the removing instructions above to reinstall.

⚠ DO NOT USE Child Restraint if any part of the harness is damaged. For proper removal and installation of the harness straps visit the Chicco website at [www.chiccouusa.com](http://www.chiccouusa.com) or call 1-877-424-4226.

## CLEANING AND MAINTENANCE

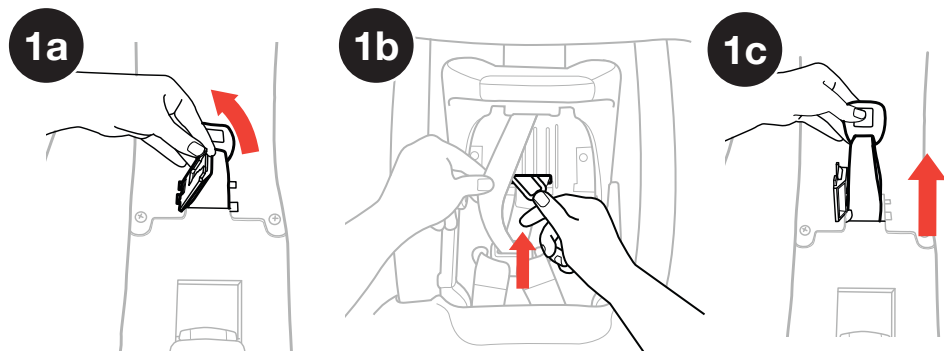
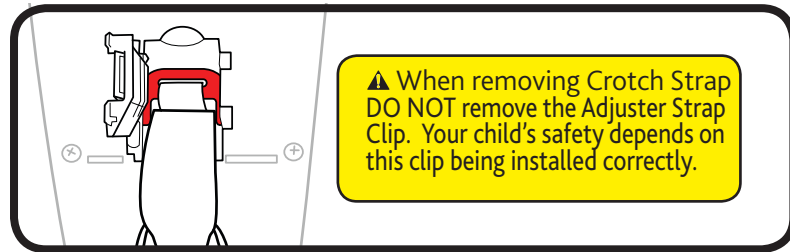

## CLEANING AND MAINTENANCE

⚠ **DO NOT USE BLEACH**, solvents or household cleaners as they may weaken plastics and straps.

⚠ **DO NOT USE SOAPS OR LUBRICANTS** on Harness Adjuster Strap, Buckle and LATCH hardware. It may cause them to malfunction.

- **Cleaning Softgoods:**

Hand wash using mild soap and water, or machine wash in cold water on delicate cycle using mild detergent. Hang to dry. See page 98 for removal instructions.

⚠ **NEVER** use Child Restraint without the seat pad.

- **Cleaning Shoulder Pads:**

Hand wash using mild soap and water. Hang to dry.

- **Cleaning Plastics:**

Sponge clean using warm water and mild soap. Towel dry.

For softgood removal instructions visit the Chicco website at [www.chiccousa.com](http://www.chiccousa.com) or call 1-877-424-4226.

## CLEANING AND MAINTENANCE

- **Cleaning Cup Holder:**

Cup Holder is dishwasher safe on top rack only.

⚠ **DO NOT USE** Child Restraint if any part of the harness is damaged. For proper removal and installation of the harness straps visit the Chicco website at [www.chiccousa.com](http://www.chiccousa.com) or call 1-877-424-4226.

- **Cleaning Harness:**

Sponge clean using warm water and mild soap. Air dry. Do NOT machine wash.

- **Cleaning LATCH and Adjuster Strap:**

LATCH Straps cannot be replaced. Sponge clean using warm water only. Air dry.

- **Cleaning Buckle and LATCH Hardware:**

Sponge clean, using warm water only. If debris in buckle, remove and rinse in warm cup of water. Air dry. See page 102 for removal instructions.



Do **NOT** remove LATCH or Adjuster straps. For additional information visit the Chicco website at [www.chiccousa.com](http://www.chiccousa.com) or call 1-877-424-4226.

